

DOORS



———— 2022 ————
DOORS
ENTRY | PATIO | STORM

PROVIA® BUILDS DOORS THE PROFESSIONAL WAY

ProVia has developed a competitive position by catering to a niche within the door market that demands a high degree of customization coupled with outstanding quality. Our company defines the products that meet this demand as “professional-class.” We have found success by adhering to a set of core values that guide us as we develop rewarding, long-term relationships with our employees, customers and homeowners.

WHAT MAKES PROVIA PROFESSIONAL-CLASS?

ENTRY SYSTEMS **TAILORED** FOR YOUR HOME

Today’s off-the-rack consumer-grade doors, which are mass-produced and not customized for your home, often fall short of expectations and performance.

These shortcomings are the driving force behind ProVia’s custom entry doors, built to your home’s exact measurements for a precise fit, protection, security, and energy efficiency. The materials that go into our custom-made doors are premium quality and exceptionally durable, far surpassing the ready-made doors at the big-box hardware stores, and our craftsmanship and care for details can be seen in each door we produce.



SECURITY | We ensure the strength and security of every door, so you have peace of mind and can focus on what’s really important - your life.



DURABILITY | Crafted with the finest materials and backed by our Lifetime Limited Transferable Warranty, the durability of our products can’t be beat.



BEAUTY | A beautiful ProVia entry system will always greet your guests with classic elegance and style.



ENERGY EFFICIENCY | Engineered to keep the elements at bay and your home comfortable all year long.





INDUSTRY ASSOCIATION

ProVia is a proud member of the Window and Door Manufacturers Association (WDMA) and American Architectural Manufacturers Association (AAMA) - leading voices in our industry. As such, we support advocacy in building code and ASTM standard arenas, quality materials, installation and design in Doors and Windows.

ENTRY DOORS

DOOR TYPE

Components.....	6-9
Embarq® Fiberglass Features.....	10
Signet® Fiberglass Features.....	14
Heritage™ Fiberglass Features.....	16
Legacy™ Steel Features.....	18
8' Doors.....	20
French Doors.....	22
Inscribed Doors.....	24
Doors Without Glass.....	26

GLASS

ComforTech™ Glazing Systems

ComforTech Benefits.....	28
--------------------------	----

Decorative Glass

Mirage.....	32
Brookhaven.....	34
Manhattan.....	36
Essence.....	38
Cheyenne.....	40
Symphony.....	42
Berkley.....	44
Laurence.....	46
Carrington.....	48
Tacoma.....	50
Somerset.....	52
Carmen.....	54
Barcelona.....	56
Constance.....	58
Tranquility.....	60
Gemstone.....	62
Eclipse.....	64
Florence.....	66
Esmond.....	68
Carlisle.....	70
Twilight.....	72

Inspirations™ Art Glass

Inspirations™ Art Glass.....	76
------------------------------	----

Privacy Glass

Privacy Glass.....	78
--------------------	----

Clear Glass

Clear Glass.....	80
White Internal Blinds.....	82
Colored Internal Blinds.....	84
Simulated Divided Lites.....	86
Simulated Divided Panels.....	88
Internal Grids.....	90
External Grids.....	93

NEW Glass Availability Charts

FINISHING TOUCHES

Stain Finishes.....	94
Paint Finishes.....	98
Trending/Custom Colors.....	100
Hardware.....	102
Speakeasy, Hinge Straps, Clavos.....	120
Pet Doors.....	122
Casing.....	123
Cladding.....	123

PATIO DOORS

Hinged Patio Doors.....	124
Vinyl Sliding Patio Doors.....	126

STORM DOORS

Features and Benefits.....	132
Paint Colors.....	135
Spectrum™.....	136
Decorator™.....	138
Deluxe™.....	140
DuraGuard™.....	142
Superview™.....	144
Hardware.....	146
Accessories.....	150

Door Type

Glass

Finishing Touches

Patio Doors

Storm Doors

WE'RE BUILDING YOUR DOORS AND OUR
COMPANY TO LAST A LIFETIME-
THAT'S THE PROFESSIONAL WAY.

**MULTI
TIME**

Partner of the
Year Award



90%+ of Windows and Doors
are ENERGY STAR®
Certified

Serving
alongside



DOORS | WINDOWS | SIDING | STONE | ROOFING



6 Facilities in the United States

1,600+

Associates Nationwide

Doing Business Since

1977

19

Core Values

200+

Metric Tons of CO²
Saved Annually

1,900+

Tons of metals, paper, glass and vinyl
recycled annually at ProVia facilities



If you ask around, you'll find attention to detail is what our customers have come to appreciate and expect from the ProVia brand. Our company is family-owned and faith-based with an intense focus on producing Professional-Class products. ProVia feels so strongly about the performance and workmanship of our entry systems—built by skilled craftspeople with state-of-the-art manufacturing processes—that they are backed with a Lifetime Limited Warranty, which is even transferable to one subsequent owner.



STYLE YOUR WAY

TAILORED **JUST FOR YOU** AT THE HIGHEST STANDARDS.

SECURITY | DURABILITY | BEAUTY | ENERGY EFFICIENCY

We make it easy for you to make the choice that's right for you. When you combine your selected door style, door glass, paint or stain finish, plus hardware and accessories, the end result is a customized entryway that reflects your personalized style.

DESIGNING YOUR DOOR

Imagine Your Entryway with a New Look. ProVia offers you endless possibilities to create a front door that provides a warm, welcoming entry to your home. To simplify the experience, we've categorized the selection process here to get you started. These ideas are just the beginning – you'll discover a myriad of additional color and style options throughout this catalog.

1 DOOR SKIN

Fiberglass and Steel door skins are available in a variety of textured and smooth options.

FIBERGLASS

SIGNET SKIN OPTIONS

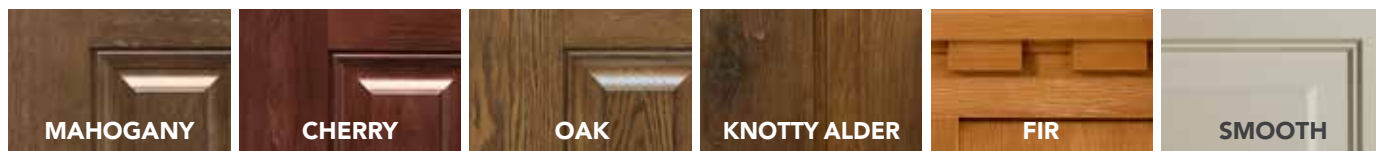

EMBARQ SKIN OPTIONS

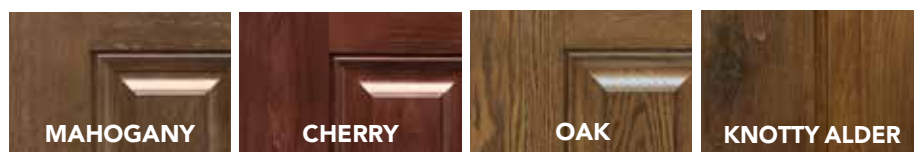

HERITAGE SKIN OPTIONS



STEEL

LEGACY SKIN OPTIONS



2 CONFIGURATION

Find and customize a configuration that best fits the opening of your home.



3 DOOR STYLES

Your home should reflect your personality. That's why you'll find a wide selection of styles to suit your taste.



4 GLASS

Select from a full line of Decorative, Art, Clear and Privacy Glass, Simulated Divided Lites, Grid Styles & Internal Blinds.



5 FINISH

Our stain and glazed finishes are hand-applied by professional craftsmen, then oven-cured for maximum beauty. Paint finishes are factory applied for a long-lasting, durable finish.



6 HARDWARE & ACCESSORIES

Hardware from Trilennium®, Hoppe®, Emtek®, Brinks® and Schlage® provide some of the most stylish, durable hardware available today. Sometimes the smallest things make the biggest difference. Our accessories add a lot to the look of your entry system.



7 ADD A STORM DOOR

Protect, enhance and ventilate your entryway with a storm door, while adding an extra measure of security.



THE COMPONENTS

The components are the small things that set our doors apart from the competition. A lot of small things add up to a big difference.



440TAC-2P, 140TAC

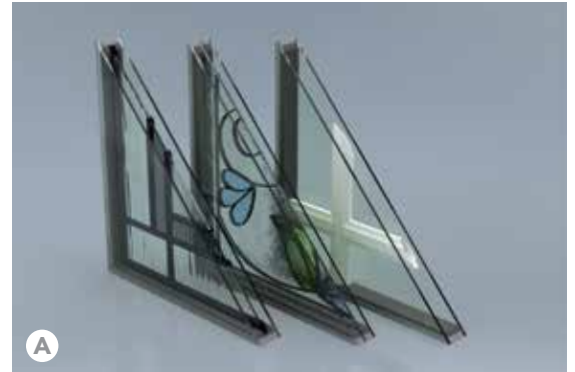

Your home is unique and deserves to have **custom glass options** like our ComforTech™ Warm Edge Glazing Systems which include decorative glass, Inspirations™ Art glass, internal blinds and internal and external grids in many grid patterns and colors.

 Impact Shield doors feature laminated glass.



Our **2½" casing** conveniently covers paint lines providing a professional installation. **Also available in 3½"**. Choose from Cherry, Mahogany, Oak and Poplar. Flat Fir and Poplar trim are available in paint, stain and glazed finishes.



High-performance, heat-resistant glass trim is warranted not to warp, crack or pull away from the door, even in sunny or higher temperature applications. **Plugless glass trim** is standard on Embarq® and Signet® and optional for Heritage™† and Legacy™†.

1. Smooth (standard on select Signet Smooth doors and sidelites, optional on select Heritage Smooth and Legacy Smooth doors and sidelites) **2.** Embarq and Signet Cherry and Mahogany **3.** Embarq and Signet Oak and Knotty Alder **4.** Signet Fir **5.** Heritage and Legacy **6.** Modern Flat Trim (only available on models 112, 114, 115, 116 and 160 sidelites)

† See price list for available styles.



The **Z-AC™ threshold** has an auto-adjusting riser and built-in sealing system that redefines how your door can perform for you. Standard on Signet and Legacy.

- **Automatically adjusts** to your entry door's changing needs over time, eliminating service calls
- Delivers **non-stop protection** against air and water infiltration
- **Saves money** and provides an improved door experience

The **ZAI™ threshold** has a manually-adjustable riser with complementary screw cover caps. Standard on Heritage.

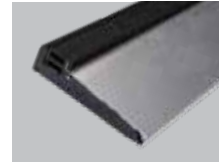

Three **heavy-duty ball bearing hinges** come standard with every entry system.

Additional 4th hinge option for greater durability. (only available with FrameSaver®)

 Impact Shield doors have heavy-duty stainless steel hinges.



The energy efficient **weatherstripping** runs along the top and sides of the door and interlocks with the **CornerShield™** for the most efficient seal you'll find for keeping moisture, wind and dirt out of your home.



We include our **20-gauge security plate** for extra strength and to help prevent kick-ins.

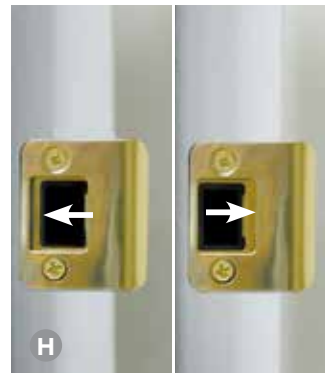

We include a **solid brass fully adjustable strike plate** of our own exclusive design. This unique 2-piece construction makes our doors easier to custom fit.



The **dust box** in the deadbolt strike provides a barrier to air infiltration while providing a nice appearance that most other door manufacturers don't provide.



Bulb and dual blade sweep virtually eliminates drafts, keeping your home comfortable.

THE COMPONENTS



FRAMES

FrameSaver®

FrameSaver wood frame and brickmold with finger-jointed composite bottom prevents water absorption and carries a Lifetime Limited Warranty when used with **PVC vinyl coated aluminum frame cladding** outside.

Also available with smooth cladding.



FusionFrame™

FusionFrame: A one-of-a-kind alternative to composite or wood jambs, this Endura® component utilizes the strength of an LVL interior, the rot-proof performance of a FrameSaver® bottom, and the durability of a composite frame exterior. Offering a lifetime jamb warranty*.

PREFINISHED, MAINTENANCE-FREE

Available as a textured or smooth frame, providing you with the benefit of a prefinished, maintenance-free system, along with the beauty of a stain or paint finish that matches your entry door.

Not available for transoms or outswing doors. See Price List for complete limitations and restrictions

**Finish warranty will match the finish warranty of door series*



PermaTech™



Our **PermaTech™ Composite door frame system** option combines all the strength and convenience of wood with enhanced properties that make it moisture and insect resistant. PermaTech will not absorb or wick moisture and will never rot or splinter, and is covered by a Lifetime Limited Warranty.*

* No storm door applied. See full warranty for limitations

Steel L-Frame

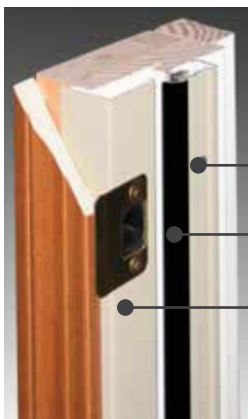

Available on select Signet and Legacy door styles

● Aluminum door stop provides greater security and is more durable than wood.

● Energy efficient weatherstripping.

● 18-gauge steel L-frame with a 12-gauge hinge plate welded on for extra strength and security.

(NOT tested for Certified Wind Load or Impact Shield regions)

Not all Steel L-Frames are ENERGY STAR® certified. Visit provia.com website for manufacturer's certification statement.

EMBARQ® FIBERGLASS

EMBARQ SKIN OPTIONS



A NEW WAY OF THINKING

We set out on a journey to develop a new door and it expanded into a complete philosophy of creating unrivaled efficiency in home building products. We call this new way of thinking "enVision," and are proud to introduce its first creation: **Embarq** – the doorway to innovation and efficiency.

15-YEAR FINISH WARRANTY*
See pgs. 95-99 for paint and stain finishes



ALL Embarq Fiberglass Entry Systems are ENERGY STAR® Certified.

EMBARQ FIBERGLASS DOOR STYLES

See pages 30-93 for glass availability.

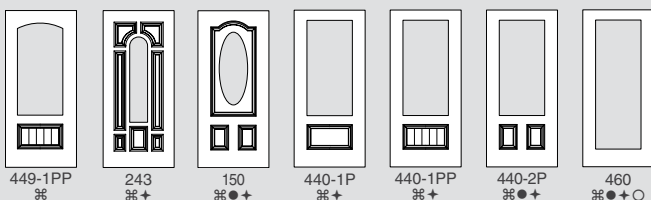
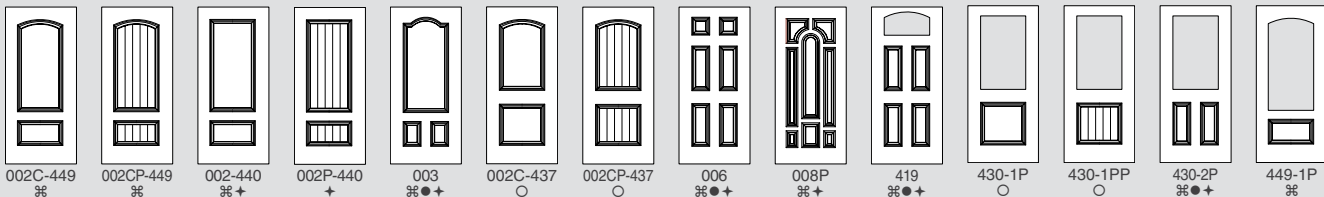

SIDELITES

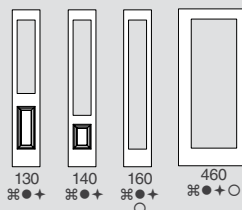

- ⌘ Embarq® Cherry
- Embarq® Mahogany
- + Embarq® Oak
- Embarq® Knotty Alder

*Warranty time period may be limited in extreme applications. See warranty for details.

Stiles and rails are dovetailed and glued at each corner creating a structurally solid, integrated frame.



To enhance efficiency and accommodate more insulation, we thickened the door and sidelites from the standard 1 1/4" to 2 1/2" which is **43% thicker** than standard exterior doors. We also engineered a **dual perimeter seal** for the entry door to create a superior barrier against drafts and energy leaks.



We engineered a channel in the side rails and header of the door to allow for a **larger energy efficient polyurethane core**. Our computer-controlled process fills every crevice with the foam barrier material resulting in **a level of energy efficiency unparalleled in the industry**.

We started from the inside out to maximize energy savings and reduce thermal loss, resulting in the most energy efficient door in the U.S. market. In fact, this door offers at least **4-times more insulating value than a typical wood door** giving an unprecedented U-Factor of 0.09 - the lowest recorded heat conduction measurement for entry doors in the U.S.

Door edge is constructed with cherry, mahogany or oak wood matching the selected series.

The **4 1/4" finger-jointed 4-ply hardwood strike stile** provides a solid mounting surface for Emtex® hardware and superior structural integrity.

The **authentic wood look** is made possible by using cutting-edge **NVD** (Nickel Vapor Deposition) technology by MasterGrain™.

Scientifically formulated compounds provide superior resistance to denting, splitting, cracking and warping.

The revolutionary **DuraFuse™ Finishing System featuring P³ Fusion** yields unprecedented finish durability.

Z-AC Threshold with auto-adjusting riser. Standard with anodized bronze finish.



We **custom-designed a sweep** to accommodate the Embarq door's added thickness. This creates a new breed of thermal barrier to keep out unwanted elements and uncomfortable temperatures.

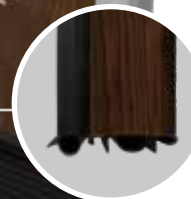

QUAD GLASS SYSTEM

Our enVision™ innovation and technology has created a revolutionary new design utilizing a Quad Glass System. This glass system is only available for Embarq fiberglass doors and sidelites and utilizes the most energy-efficient glass package available on the market today. This high performance glass system provides an optimal energy efficiency rating.

- A** Low-E Glass Surface
- B** Krypton Filled Air Space
- C** Decorative Glass Core
- D** Super Spacer®
- E** Tri-Seal Spacer
- F** We re-engineered our ComforTech Warm Edge Glazing System to accommodate for the extra panes of glass in this highly efficient package.

EMBARQ GLASS PACKAGES

ComforTech™ **QLK**
(Krypton Gas Filled)

●●●●●●●●●●

R-Value of 10

ComforTech™ **QLA**
(Argon Gas Filled)

●●●●●●●●○

R-Value of 9

R-Value reflects properties of the glass only.
Embarq glass package center of glass calculations.



SKINS AND FINISHES

Embarq doors available in Cherry, Mahogany, Oak and Knotty Alder and feature all the same stain and paint finishes as our Signet® doors shown on pgs. 95-99.

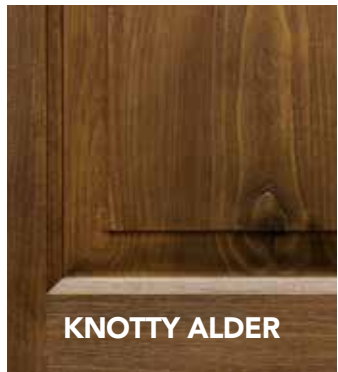

HARDWARE

Embarq doors are only available with Emtek® hardware. See pg. 108-111 for finish availability.

EXTERIOR STYLES



Melrose Orleans Marietta Davos

INTERIOR STYLES (Any interior handle can be used with any exterior handle)



Egg (Recommended on Melrose) Egg (Recommended on Marietta) Cortina (Recommended on Orleans) Stuttgart (Recommended on Davos)

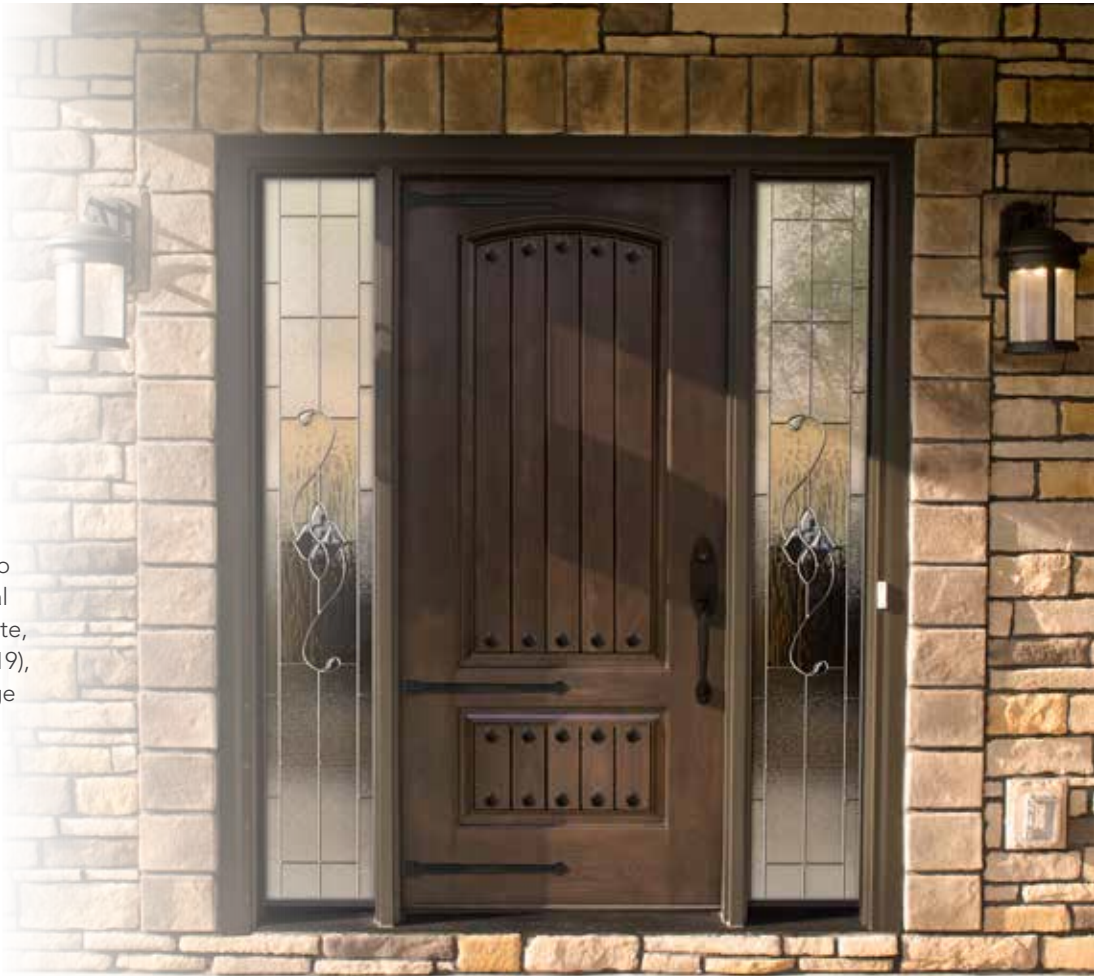

Embarq doors are also available with Colonial Door Knocker, Peepsite, Kick Plate (on page 119), Faux Speakeasy, Hinge Straps and Clavos (on page 120-121).

Satin Nickel casing with Bronze hardware

SIGNET® FIBERGLASS

SIGNET SKIN OPTIONS



All fir doors now standard with plugless trim.

Signet Fiberglass doors are available in Cherry, Mahogany, Oak, Fir, Knotty Alder and Smooth Series. Structurally, the Signet door is far superior to traditional fiberglass doors with robust hardwood stiles and rails dovetailed at each corner. All Signet Fiberglass doors exhibit our exclusive DuraFuse™ Finishing System featuring P³ Fusion, allowing us to offer an industry-best 15-year* finish warranty.



Most Signet Fiberglass Entry Systems are ENERGY STAR® Certified.

15-YEAR FINISH WARRANTY*
See pgs. 95-99 for paint and stain finishes



CUSTOMIZE BOTH SIDES

You can customize your entry by ordering a different series, style and finish on each side of your door.



CUSTOM WIDTHS & HEIGHTS

Need a little more height or a little less width? We offer customized door and sidelite widths and heights in 1/8" increments.

SIGNET FIBERGLASS DOOR STYLES See pages 30-93 for glass availability.

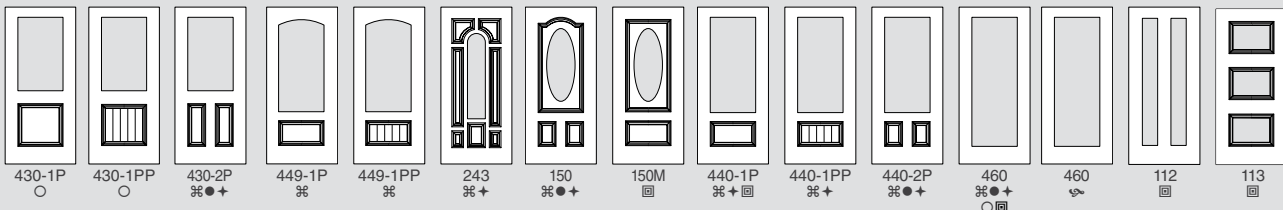
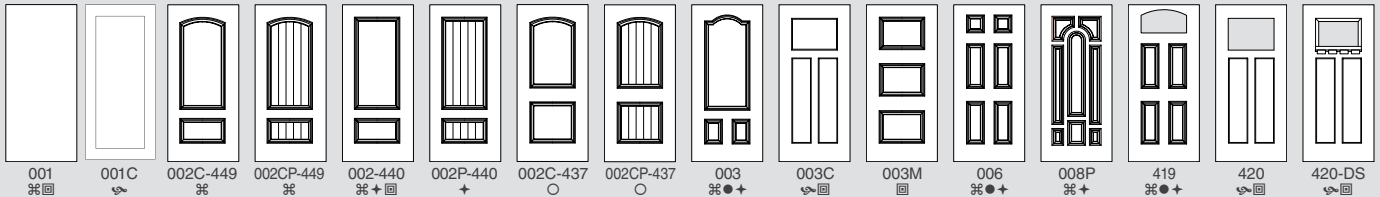

SIDELITES

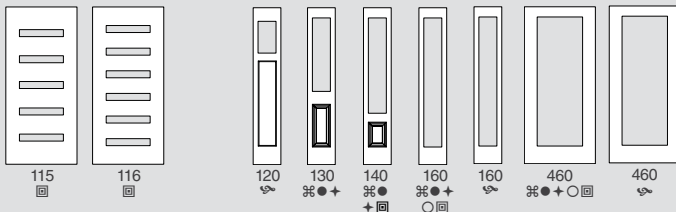

Entry System U-Factor: As low as .16 (Tested to NFRC specifications for a 6 panel door with wood frame).

Note: All Signet doors are shipped finished.

* Warranty time period may be limited in extreme applications. See warranty for details.

† Patents - USD617005, USD621062, USD621063, USD625837, USD625024

- ☞ Signet Cherry
- Signet Mahogany
- + Signet Oak
- Signet Knotty Alder
- ☞ Signet Fir
- ☐ Signet Smooth



HERITAGE™ FIBERGLASS

HERITAGE SKIN OPTIONS



Heritage Fiberglass doors feature enhanced woodgrain texture, improved definition embossing and a hardwood edge to prevent warping.



Most Heritage Fiberglass Entry Systems are ENERGY STAR® Certified.

10-YEAR FINISH WARRANTY*

See pgs. 95-99 for paint and stain finishes



CUSTOM HEIGHTS

Need a little more or a little less height? We offer customized door and sidelite heights in 1/8" increments.

HERITAGE FIBERGLASS DOOR STYLES See pages 30-93 for glass availability.

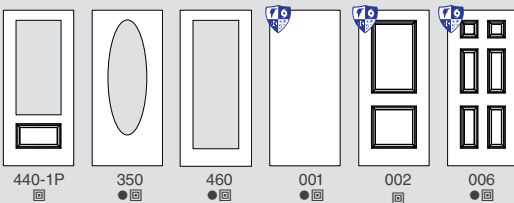
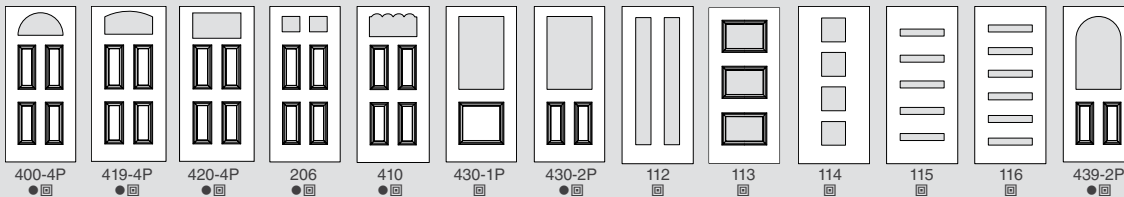

SIDELITES

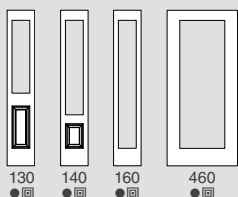

- Oak Grain
- ▣ Smooth Fiberglass

Only Heritage Fiberglass doors without glass are available as an Impact Shield Product.

Entry System U-Factor: As low as .14 (Tested to NFRC specifications for a 6 panel door with wood frame).

* Warranty time period may be limited in extreme applications. See warranty for details.



Polyurethane core reduces energy loss.

Improved definition panel profile creates excellent shadow lines and distinct panel designs.

Specially engineered fiberglass door facings will not dent and resist splitting, cracking and warping.

Plugless Glass Trim is optional on Heritage Fiberglass (see Price List for available styles)

ZAI™ threshold has a manually-adjustable riser with complementary screw cover caps. Standard with aluminum mill finish.

1 1/2" Finger-jointed, 2-ply solid oak laminated stiles for both hinge and strike sides are proven to provide increased rigidity and structural integrity.

Variable-depth woodgrain texture with hand-applied stain imitates a wood door appearance.

Square-edge design offers an attractive wood door appearance.

Lock area is reinforced to provide a solid mounting surface for decorative hardware.

A high-performance, composite material is utilized on all Heritage fiberglass bottom rails, giving excellent rot-resistance.

LEGACY™ STEEL

LEGACY SKIN OPTIONS



Legacy Steel features add up to a professional-class product. Whether you select Legacy Woodgrain Textured Steel or Smooth Steel, our entry systems will provide an elegant, durable and energy efficient addition to any home.

10-YEAR FINISH WARRANTY*
See pgs. 95-99 for paint and stain finishes



Most Legacy Steel Entry Systems are ENERGY STAR® Certified.

Legacy Steel Doors with full-lite or half-lite decorative glass with ComforTech™ glazing will include a pane of Low-E glass in order to be ENERGY STAR certified. This includes the following styles; 150, 230, 239, 240, 350, 430, 437, 439 and 460. Since Low-E glass has a slight color tint, it is recommended that sidelites and transoms are ordered with optional Low-E pane to match the door.



CUSTOMIZE BOTH SIDES
You can customize your entry by ordering a different series, style and finish on each side of your door.



CUSTOM WIDTHS & HEIGHTS
Need a little more height or a little less width? We offer customized door and sidelite widths and heights in 1/8" increments.

LEGACY STEEL DOOR STYLES See pages 30-93 for glass availability.

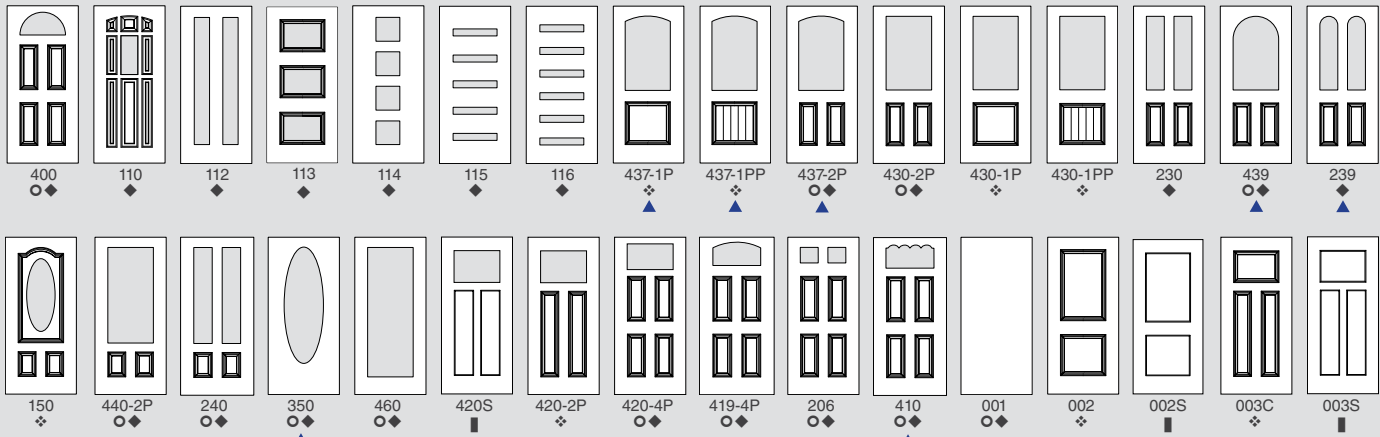

SIDELITES

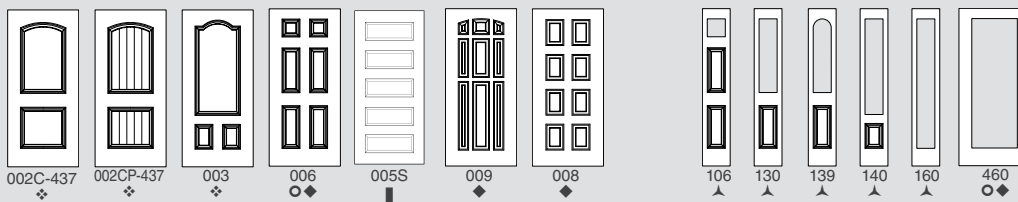

- 20-gauge Woodgrain Textured Steel
- ◆ 20-gauge Smooth Steel
- ❖ 20-gauge Smooth Steel with High-Definition Embossing
- ▲ 24-gauge Smooth or Textured Steel (used with all 20-gauge doors)
- 20-gauge smooth shaker

Entry System U-Factor: As low as .17 (Tested to NFRC specifications for a 6 panel door with wood frame).

* Warranty time period may be limited in extreme applications. See warranty for details.

† Patent - USD621062

▲ NOT available as an Impact Shield product



Composite top endcaps increase rigidity and energy efficiency.

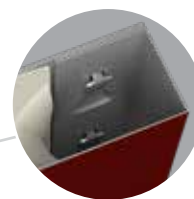

Special adhesives/thermal barrier reduce heat and cold transfer, while our exclusive tab and slot system of **mechanical interlocks** gives the door exceptional structural strength.

ProVia doors are **foam filled by a computer driven process** that ensures the optimal foam fill for maximum energy efficiency and strength.

The edges and face skin of our steel doors are **one continuous piece of steel** for strength and durability.

Plugless Glass Trim is optional on Legacy Steel (see Price List for available styles)

To reinforce the lock and deadbolt area, we add a **rigid composite lock block** to all of our steel doors.

Our 20-gauge steel doors give you **49% more galvanized steel** than a standard 24-gauge door.



Composite bottom endcaps increase rigidity and energy efficiency.

Z-AC Threshold with auto-adjusting riser. Standard with aluminum mill finish.



8' DOORS

8' Doors provide a majestic first impression. Choose from many available glass and door styles (shown on pgs. 30-93). Trilennium® multi-point hardware offers homeowners better door closure and sealing than a single point lock.

Trilennium or Hoppe multi-point hardware is required on all 8' fiberglass doors. See pages 104-107 for more information on Trilennium and Hoppe hardware.



SIGNET FIBERGLASS DOOR STYLES

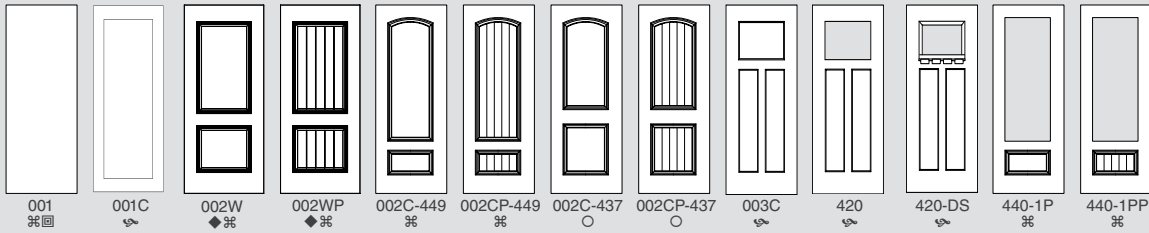

SIDELITES

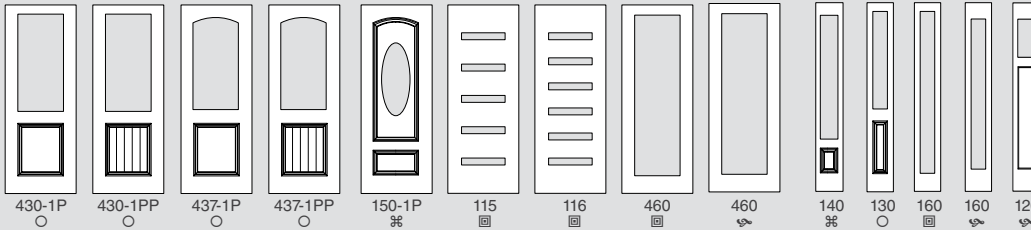

- ⌘ Signet Cherry
- Signet Mahogany
- + Signet Oak
- Signet Knotty Alder
- ⌘ Signet Fir
- ⬢ Signet Smooth
- ◆ Only available in 42" x 96" size

Entry System U-Factor: As low as .16 (Tested to NFRC specifications for a 6 panel door with wood frame).
 Note: All Signet doors are shipped finished.

* Warranty time period may be limited in extreme applications. See warranty for details.
 † Patents - USD617005, USD621062, USD621063, USD625837, USD625024

HERITAGE FIBERGLASS DOOR STYLES

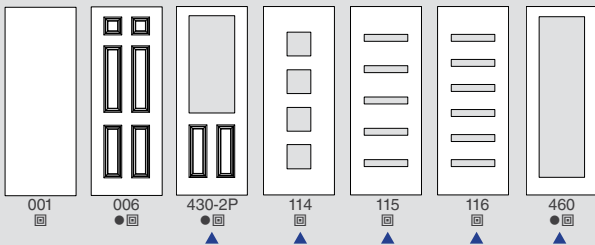

- Oak Grain
- ⊞ Smooth Fiberglass

SIDELITES

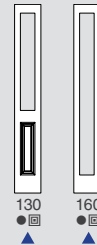

Entry System U-Factor: As low as .14
 (Tested to NFRC specifications for a 6 panel door with wood frame).
 * Warranty time period may be limited in extreme applications. See warranty for details.

LEGACY STEEL DOOR STYLES

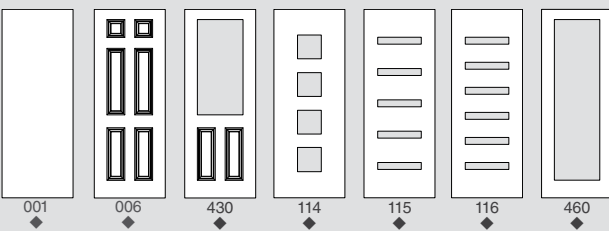

- 20-gauge Woodgrain Textured Steel
- ◆ 20-gauge Smooth Steel
- ❖ 20-gauge Smooth Steel with High-Definition Embossing
- ▲ 24-gauge Smooth or Textured Steel (used with all 20-gauge doors)

SIDELITES

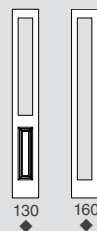

Entry System U-Factor: As low as .17 (Tested to NFRC specifications for a 6 panel door with wood frame).
 * Warranty time period may be limited in extreme applications. See warranty for details.
 † Patent - USD621062

▲ NOT available as an Impact Shield product

FRENCH DOORS

French doors make an elegant statement like nothing else. Express your personality by creating a simple yet striking entry. Make it as ornate and beautiful as you like.



FRENCH DOOR DETAILS

- All door styles are available as a French Door
- Available with FrameSaver® or Steel L-Frame
- Hinged on each end with door knobs in the center
- Available with either left or right active door (main entryway)
- Center astragal is attached to the inactive door and includes top and bottom slide bolts (used to open inactive door)
- Available as inswing or outswing
- Header security plate standard on frame
- Hardware Installation: locksets, deadbolts and kickplates will be installed on active and inactive doors, all other hardware on active door only
- Also available with Trilennium hardware

ASTRAGAL DETAILS

The French Door Astragal provides functionality and security



Astragal secures inactive door at top and bottom of your french door system



Lockable throw bolts improve security



Astragal bolt penetrates threshold allowing boot to seal, creating a better barrier against the elements



Astragal is stained to match Signet Fiberglass stained doors.

STYLES/CONFIGURATIONS

All door styles are available as a French Door.
(See pages 10-21 for [Impact Shield](#) & [Windload](#) availability)

Custom size clear glass transom

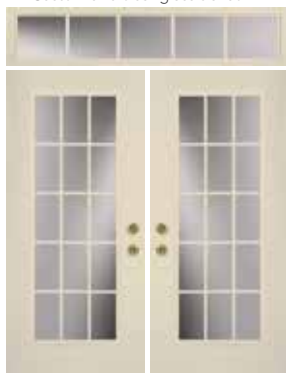

460DC-IGT

460DC-IGT



160SYA

460SYA

460SYA

160SYA



460LAU

460LAU

⚠ Cannot be mulled with Heritage Fiberglass doors in Certified Wind Load regions



UNEQUAL FRENCH DOORS

You now have the ability to utilize the larger entry door day-to-day, yet have the option to open the smaller, inactive door to gain full access.

Available in smooth steel only. Internal blind sizes are limited. See Price List for details.

345

INSCRIBED DOORS

Elegant and refined to complement an entrance way. Each design is engraved into a Signet® Cherry fiberglass panel showcasing true richness of color and sophistication. Also available with three stainless steel inlay models.

INSCRIBED STYLES (Only available in flush Signet cherry doors.)



001-INS3C



001-INS3-HN



001-INS6



001-INS5

STAINLESS STEEL INLAY STYLES (Only available in flush Signet cherry doors.)



001-INL4



001-INL4S



001-INL6

AVAILABLE COLORS

CHERRY STAINS

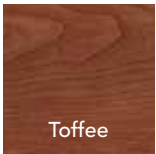

Toffee

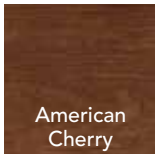

American
Cherry

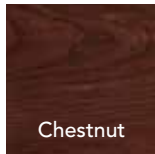

Chestnut

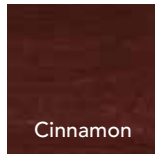

Cinnamon

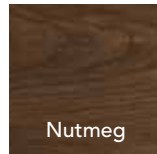

Nutmeg

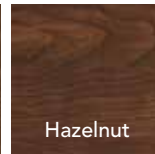

Hazelnut

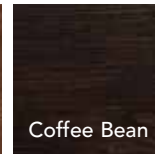

Coffee Bean

15-YEAR FINISH WARRANTY*

Embarq and Signet Fiberglass

*Warranty time period may be limited in extreme exposure applications. See warranty for details.

DOORS WITHOUT GLASS

Doors Without Glass will fill your needs beautifully when privacy is needed.

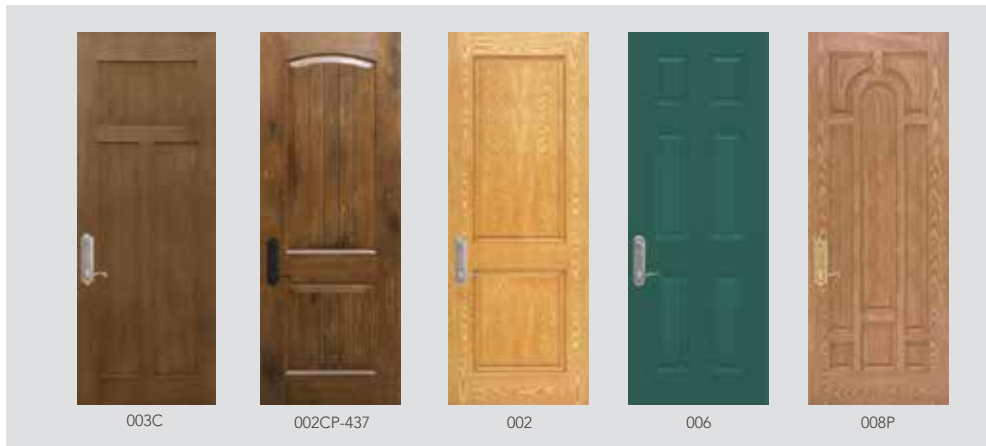



DOORS WITHOUT GLASS STYLE AVAILABILITY (See pages 10-21 for **Impact Shield** & **Windload** availability)

	Doors																
	009	008P	008	006	004	005	003M	003	003C	002S	002C(P)-449	002	002C(P)-437	002-440	002P-440	001C	001
Embarq / Signet Mahogany Series				•				•									
Embarq / Signet Cherry Series	•		•					•						•			•
Embarq / Signet Oak Series	•		•					•						•	•		
Signet Fir Series																	•
Embarq / Signet Knotty Alder Series													•				
Signet Smooth Series																	•
Heritage Woodgrain Textured Fiberglass			•	•													•
Heritage Smooth Fiberglass			•	•													•
20-Gauge Woodgrain Textured Steel			•														•
20-Gauge Smooth Steel	•		•	•													•

	8' Doors								
	001	001C	002W(P)	002C(P)-449	002C(P)-437	002	003S	006	008P
Embarq / Signet Cherry Series	*		*		*				
Signet Fir Series		•							•
Embarq / Signet Knotty Alder Series						*			
Signet Smooth Series	•								
Heritage Woodgrain Textured Fiberglass								•	•
Heritage Smooth Fiberglass	•								•
20-Gauge Smooth Steel	•								•

* Embarq doors and sidelites are not available in 8' heights

◆ Only available in 42" x 96" size



All Entry Systems Without Glass are ENERGY STAR® Certified.

COMFORTECH™

LIFETIME LIMITED WARRANTY
Includes Glass Breakage and Seal Failure

Measurably improve thermal performance with the ComforTech™ Warm Edge Glazing System. You'll enjoy better energy efficiency and a warmer glass edge.

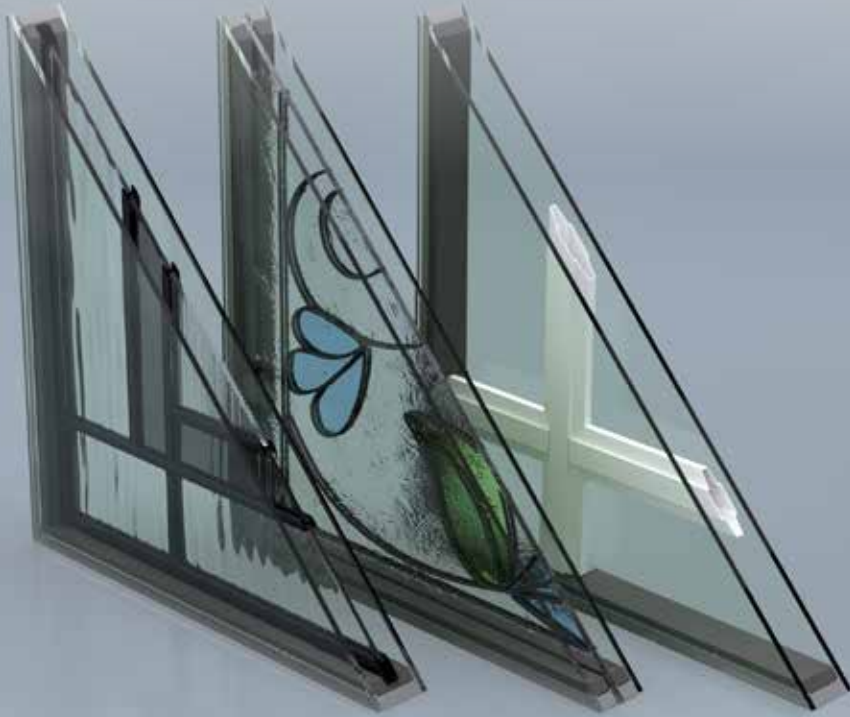

COMFORTECH ADVANTAGES



The NO-Metal Advantage

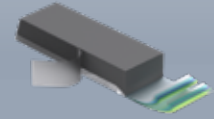

Mylar 10-Layer Vapor Barrier



Withstands Normal Bowing



Enhanced Noise Reduction

COMFORTECH WARM EDGE GLAZING SYSTEM IS INCLUDED IN ALL:

- Decorative Glass
- Inspirations™ Art Glass
- Privacy Glass
- Clear Glass
- Grids (Internal, External and SDL)

GLAZING SYSTEM OPTIONS

ComforTech™ **TLK**
ComforTech™ **TLK-UV**



●●●●●●●●●●
R-Value of 10

ComforTech™ **TLA**
ComforTech™ **TLA-UV**



●●●●●●●●○○
R-Value of 7

ComforTech™ **DLA**
ComforTech™ **DLA-UV**

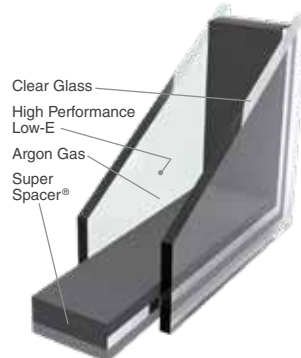

●●●●○○○○○○
R-Value of 4

ComforTech™ **DC**

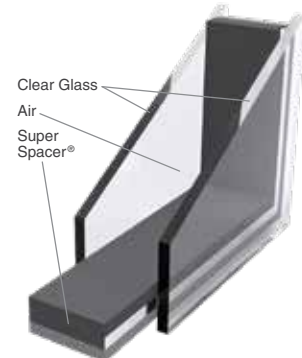

●●○○○○○○○○
R-Value of 2

R-Value reflects properties of the glass only. Center of glass calculations are based upon software from Lawrence Berkeley National Laboratory.

ELEVATION SERIES

for customers in high altitude areas

Insulated glass without Argon or Krypton. Capillary tubes are open and inserted behind glazing bead. Low-E softcoat and hardcoat available for vinyl patio doors.



ComforTech™ **TLE**
ComforTech™ **TLE-UV**



ComforTech™ **DLE**
ComforTech™ **DLE-UV**

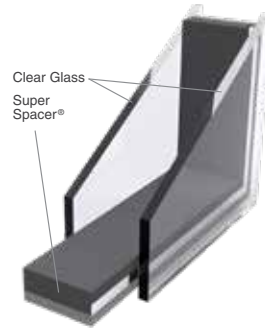

ComforTech™ **DE**



Understanding the Acronyms

- T** - Triple Glazed
- D** - Double Glazed
- L** - Low E
- C** - Clear
- A** - Argon
- K** - Krypton
- E** - Elevation (no gas)
- UV** - Ultraviolet
- HC** - Hard Coat

Some Elevation Series (TLE-UV, TLE, DLE-UV and DLE) glass offerings require a hardcoat option to be ENERGY STAR® compliant.

IMPACT SHIELD

All Impact Shield products feature ComforTech™ laminated glass.

ComforTech™ **TLK-C**
ComforTech™ **TLK-UV-C**



ComforTech™ **TLA-C**
ComforTech™ **TLA-UV-C**

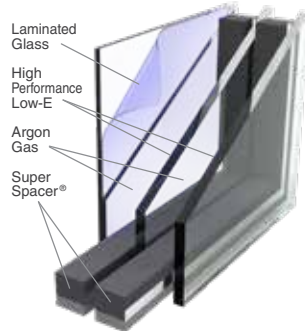

ComforTech™ **DLA-C**
ComforTech™ **DLA-UV-C**

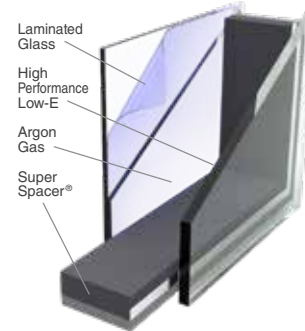

ComforTech™ **DC-C**

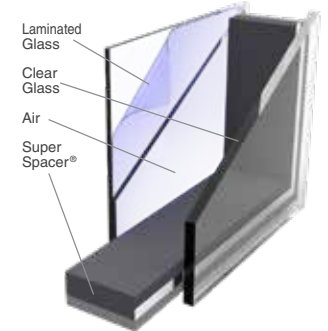

R-Value reflects properties of the glass only. Center of glass calculations are based upon software from Lawrence Berkeley National Laboratory.

FLORIDA

Impact Shield products are designed to protect your family and home against the harshest storms and deter burglars. All entry systems and patio doors in this Impact Shield products section are wind-borne debris resistant and approved by the state of Florida. floridabuilding.org

- Impact Shield
- Certified Wind Load
- High-Velocity Hurricane Zones
(ProVia products have not been tested for use in High-Velocity Hurricane Zones)



DECORATIVE GLASS



Highly-skilled craftsmen assemble hand-beveled glass accented with a variety of unique glass options by precisely cutting, mitering and soldering each component into artistically designed patterns.

Decorative glass purposefully seeks visual character through aesthetic imperfections, while maintaining structural stability. These "imperfections" mimic the hand-made sheet glass of centuries past. They come in the form of textural waves and striations, random seeds (air bubbles) and a variety of other natural effects.

Decorative glass achieves its personality through these apparent flaws and no two sheets are ever identical. Each glass panel is hand-made and reflects minor differences from piece to piece. This is characteristic of any hand-made product and adds to the charm and beauty of the product.

We continually inspect for consistency. The patterns can vary in size and particular shapes, but pose no danger of spontaneous breakage or structural instability. Any patterns that are severely out of character with the glass are not accepted. Our goal is to provide the finest quality glass panels.

ALL DECORATIVE GLASS:

1. ProVia Exclusive

These decorative glass designs are only found on ProVia doors. This gives your entryway a unique style that can't be found anywhere else.

2. Includes ComforTech™ Warm Edge Glazing System

Measurably improve thermal performance with our ComforTech Warm Edge Glazing System. You'll enjoy better energy efficiency and a warmer glass edge.

3. Impact Shield available

Impact Shield Products are designed to protect your family and home against the harshest storms and help deter burglaries. Impact Shield products feature laminated glass and can withstand repeated blows from wind-borne debris or unwanted intruders.

4. Covered by a Lifetime Limited Warranty

Warranty includes glass breakage and seal failure.





Each piece of glass is meticulously cleaned and inspected for consistency.



MIRAGE

DECORATIVE GLASS

Mirage offers effortless style, with narrow/thin reed glass all over, complemented by clear beveled glass. Zinc caming tops it off, making it a simple, modern and attractive design.

CAMING FINISH



PRIVACY RATING

1 2 3 4 5 6 **7** 8 9 10

less privacy

more privacy

LIFETIME LIMITED WARRANTY

Includes Glass Breakage & Seal Failure



All full wood frame and composite frame entry systems using Mirage Glass are ENERGY STAR® Certified and some steel L-Frame entry systems using Mirage Glass are ENERGY STAR Certified. See the ENERGY STAR section of our website for energy ratings on specific styles.

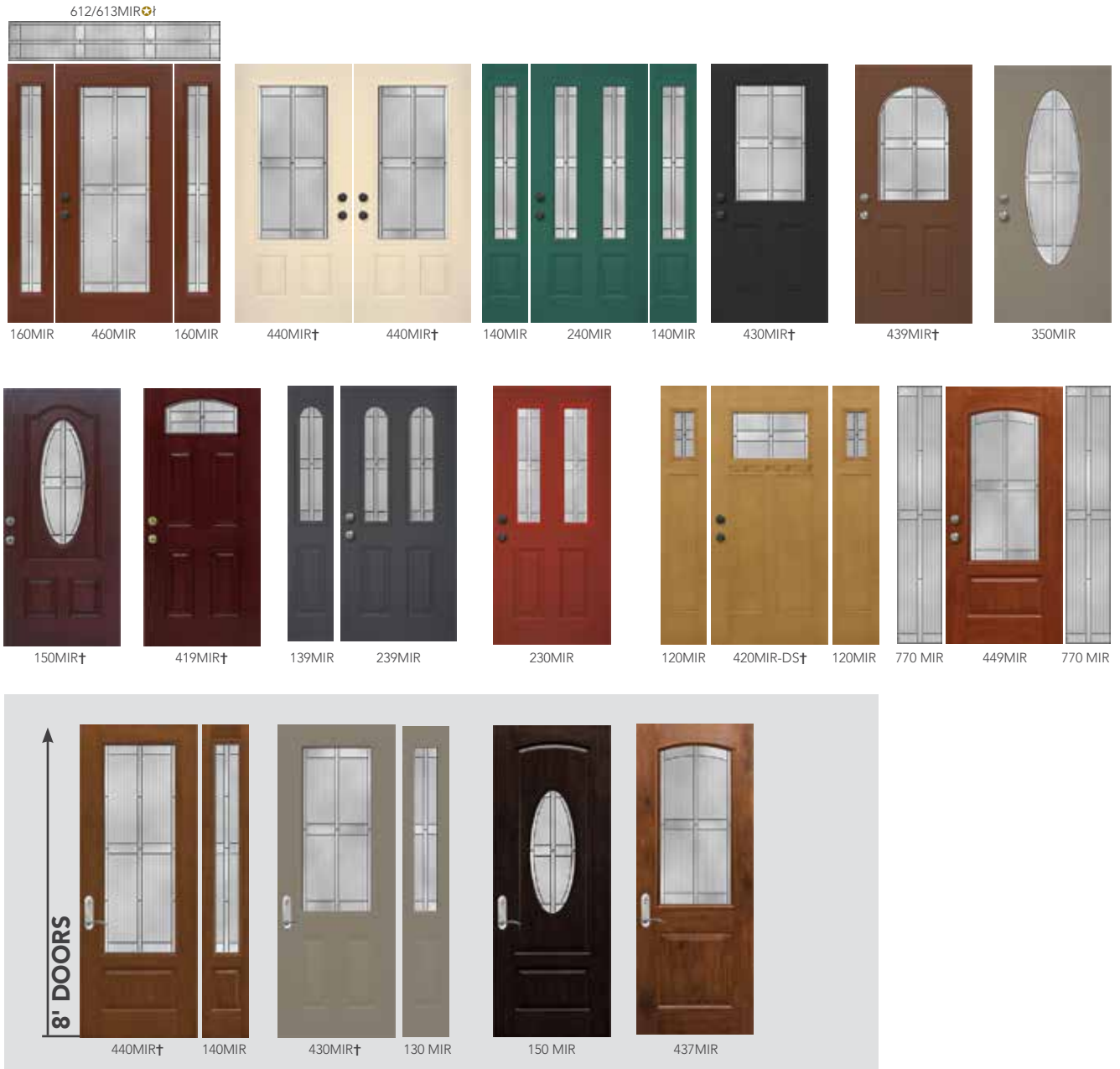

Mirage Glass

† For additional door panel styles see pg. 10 (for Embarq®), pg. 14 (for Signet®), pg. 16 (for Heritage™) or pg. 18 (for Legacy™)

‡ Requires an additional 6-week lead time

⊛ Cannot be mulled with Heritage Fiberglass doors in Certified Wind Load regions



BROOKHAVEN

DECORATIVE GLASS

Brookhaven is accented with gray antique glass, giving it a subtle hint of color. The hammered glass delivers some privacy and is accentuated with clear beveled and microcubed glass throughout.

CAMING FINISH



Specify caming finish using these codes:
Zinc - BRZ, Patina - BRP

PRIVACY RATING

1 2 3 4 5 6 7 **8** 9 10

less privacy

more privacy

LIFETIME LIMITED WARRANTY

Includes Glass Breakage & Seal Failure



All full wood frame and composite frame entry systems using Brookhaven Glass are ENERGY STAR® Certified and some steel L-Frame entry systems using Brookhaven Glass are ENERGY STAR Certified. See the ENERGY STAR section of our website for energy ratings on specific styles.



612/613BRO



160BRO 460BRO 160BRO



140BRO 440BRO† 140BRO



449BRO



350BRO



150BRO†



240BRO



243BRO



130BRO 430BRO†



439BRO †



230BRO



139BRO 239BRO

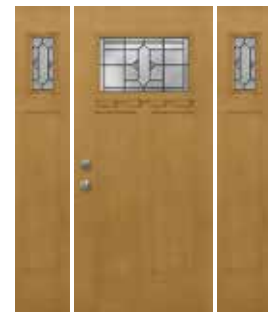

120BRO 420BRO-DS 120BRO



419BRO†



400BRO†



8' DOORS

440BRO† 140BRO 430BRO† 130BRO 437BRO† 150BRO

§ Also available in 10" width (which requires an additional 4-week lead time). See Price List for design pattern
 † Requires an additional 6-week lead time

† For additional door panel styles see pg. 10 (for Embarq®), pg. 14 (for Signet®), pg. 16 (for Heritage™) or pg. 18 (for Legacy™)
 ☼ Cannot be mullied with Heritage Fiberglass doors in Certified Wind Load regions

Brookhaven Glass



Streamed

Caming

Clear Beveled

Gray Softwave



MANHATTAN

DECORATIVE GLASS

Manhattan features streamed glass, clear bevels and gray softwave, combining simplicity and modern style. Accent it with either patina or zinc caming to customize the look.

CAMING FINISH



Specify caming finish using these codes:
Zinc - MAZ, Patina - MAP

PRIVACY RATING

1 2 3 4 5 6 7 **8** 9 10

less privacy

more privacy

LIFETIME LIMITED WARRANTY

Includes Glass Breakage & Seal Failure



All full wood frame and composite frame entry systems using Manhattan Glass are ENERGY STAR® Certified and some steel L-Frame entry systems using Manhattan Glass are ENERGY STAR Certified. See the ENERGY STAR section of our website for energy ratings on specific styles.



† For additional door panel styles see pg. 10 (for Embarq®), pg. 14 (for Signet®), pg. 16 (for Heritage™) or pg. 18 (for Legacy™)
 ‡ Requires an additional 6-week lead time
 ☼ Cannot be mulled with Heritage Fiberglass doors in Certified Wind Load regions



ESSENCE

DECORATIVE GLASS

Essence features a bronze softwave glass combined with micro-granite that brings elegance to a whole new level.

CAMING FINISH



Specify caming finish using these codes:
Brass - ESB, Zinc - ESZ

PRIVACY RATING

1 2 3 4 5 **6** 7 8 9 10

less privacy

more privacy

LIFETIME LIMITED WARRANTY

Includes Glass Breakage & Seal Failure



All full wood frame and composite frame entry systems using Essence Glass are ENERGY STAR® Certified and some steel L-Frame entry systems using Essence Glass are ENERGY STAR Certified. See the ENERGY STAR section of our website for energy ratings on specific styles.

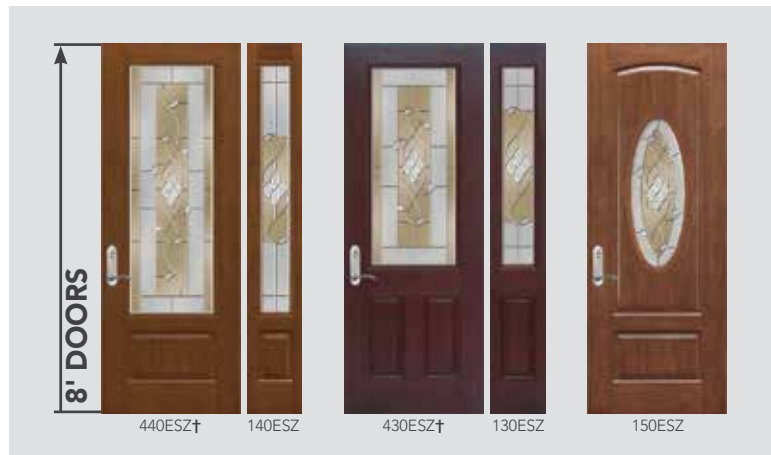

Essence Glass

† For additional door panel styles see pg. 10 (for Embarq®), pg. 14 (for Signet®), pg. 16 (for Heritage™) or pg. 18 (for Legacy™)
 § Also available in 10" width (which requires an additional 4-week lead time). See Price List for design pattern
 ‡ Requires an additional 6-week lead time
 ☼ Cannot be mulled with Heritage Fiberglass doors in Certified Wind Load regions



CHEYENNE

DECORATIVE GLASS

Cheyenne features micro-granite, hammered and beveled glass that will add elegance to your entryway, while providing a high level of privacy.

CAMING FINISH



Specify caming finish using these codes:
Patina - CHP, Zinc - CHZ

PRIVACY RATING

1 2 3 4 5 6 7 **8** 9 10

less privacy

more privacy

LIFETIME LIMITED WARRANTY

Includes Glass Breakage & Seal Failure



All full wood frame and composite frame entry systems using Cheyenne Glass are ENERGY STAR® Certified and some steel L-Frame entry systems using Cheyenne Glass are ENERGY STAR Certified. See the ENERGY STAR section of our website for energy ratings on specific styles.

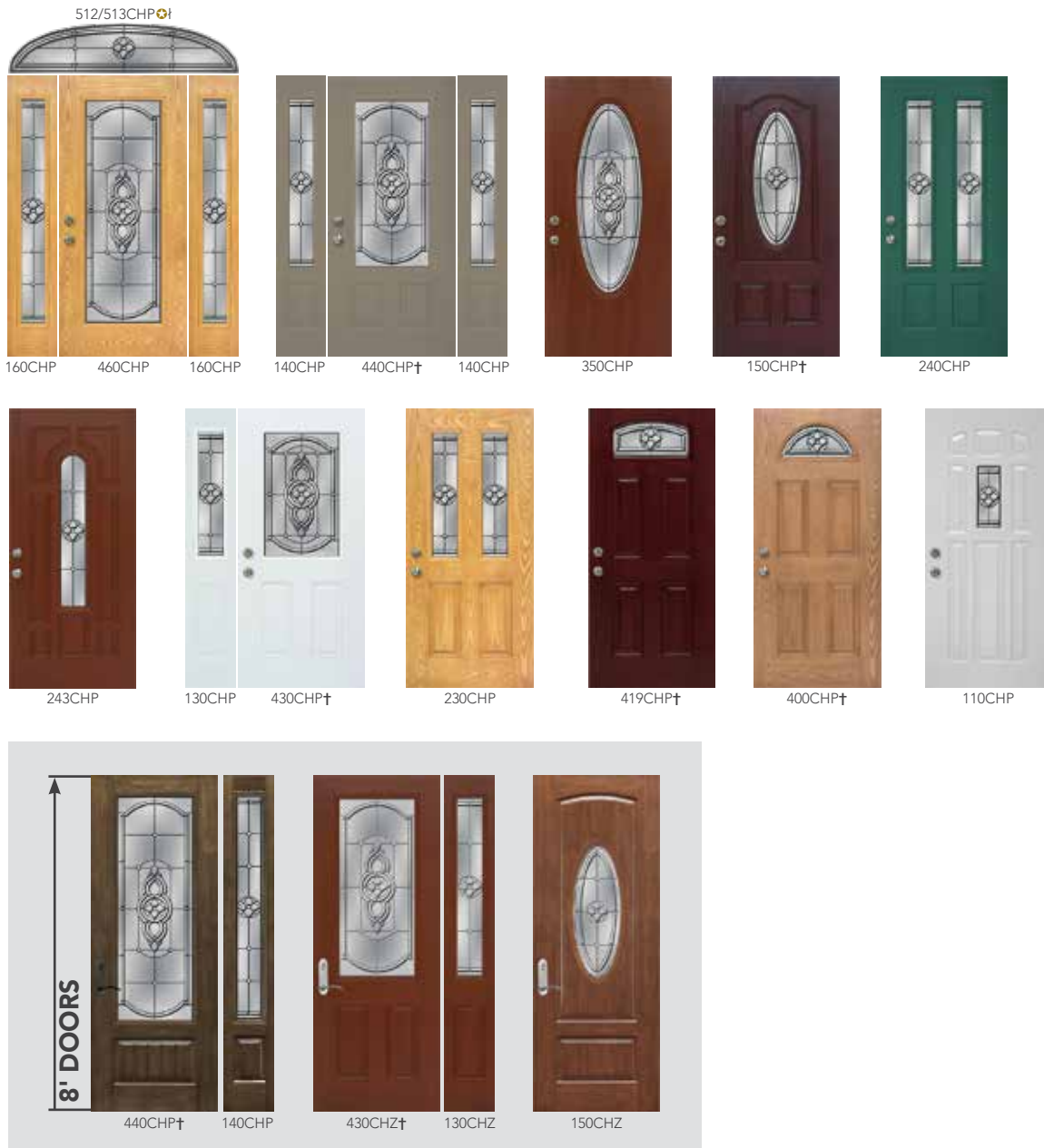

Cheyenne Glass

† For additional door panel styles see pg. 10 (for Embarq®), pg. 14 (for Signet®), pg. 16 (for Heritage™) or pg. 18 (for Legacy™)
 ‡ Requires an additional 6-week lead time
 ☼ Cannot be mulled with Heritage Fiberglass doors in Certified Wind Load regions



SYMPHONY

DECORATIVE GLASS

Symphony features a bronze softwave and expresses timeless beauty and elegance at every curve. This design is sure to bring you a pleasing and melodious style.

CAMING FINISH



Specify caming finish using these codes:
Brass - SYB, Patina - SYP, Zinc - SYZ

PRIVACY RATING

1 2 3 4 **5** 6 7 8 9 10

less privacy

more privacy

LIFETIME LIMITED WARRANTY

Includes Glass Breakage & Seal Failure



All full wood frame and composite frame entry systems using Symphony Glass are ENERGY STAR® Certified and some steel L-Frame entry systems using Symphony Glass are ENERGY STAR Certified. See the ENERGY STAR section of our website for energy ratings on specific styles.



160SYA 460SYA 160SYA 140SYA 440SYA † 140SYA 160SYA 350SYA 160SYA 770SYA † § † 449SYA † 770SYA † § † 150SYA †



240SYA 243SYA 130SYA 430SYA † 230SYA 120SYA 420SYA-DS 120SYA 419SYA † 400SYA †



460SYA 160SYA 440SYA † 140SYA 430SYA † 130SYA 437SYA † 150SYA

Symphony Glass

§ Also available in 10" width (which requires an additional 4-week lead time). See Price List for design pattern
 † Requires an additional 6-week lead time

‡ For additional door panel styles see pg. 10 (for Embarq®), pg. 14 (for Signet®), pg. 16 (for Heritage™) or pg. 18 (for Legacy™)
 † Cannot be milled with Heritage Fiberglass doors in Certified Wind Load regions
 * In Certified Wind Load region, indicated transoms must be installed in a separate opening or use approved engineering mulls



BERKLEY

DECORATIVE GLASS

Berkley features micro-iced granite, clear bevels, and small hammered with a timeless herringbone pattern that complements modern, contemporary and Arts & Crafts architecture.

CAMING FINISH

- Antique Brass
- Zinc
- Patina

Specify caming finish using these codes:
 Antique Brass - BEA, Zinc - BEZ,
 Patina - BEP

PRIVACY RATING

1 2 3 4 5 6 **7** 8 9 10

less privacy more privacy

LIFETIME LIMITED WARRANTY

Includes Glass Breakage & Seal Failure



All full wood frame and composite frame entry systems using Berkley Glass are ENERGY STAR® Certified and some steel L-Frame entry systems using Berkley Glass are ENERGY STAR Certified. See the ENERGY STAR section of our website for energy ratings on specific styles.

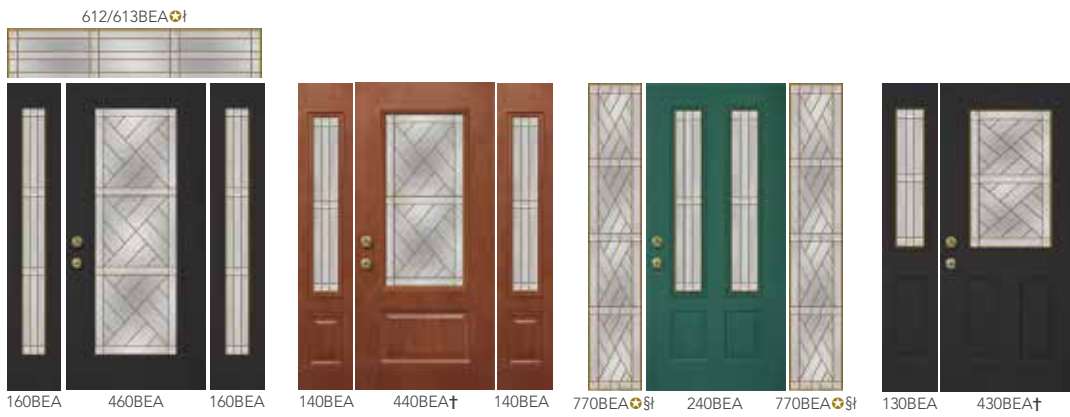

§ Also available in 10" width (which requires an additional 4-week lead time). See Price List for design pattern
 † Requires an additional 6-week lead time

‡ For additional door panel styles see pg. 10 (for Embarq®), pg. 14 (for Signet®), pg. 16 (for Heritage™) or pg. 18 (for Legacy™)
 ‡ Cannot be mulled with Heritage Fiberglass doors in Certified Wind Load regions

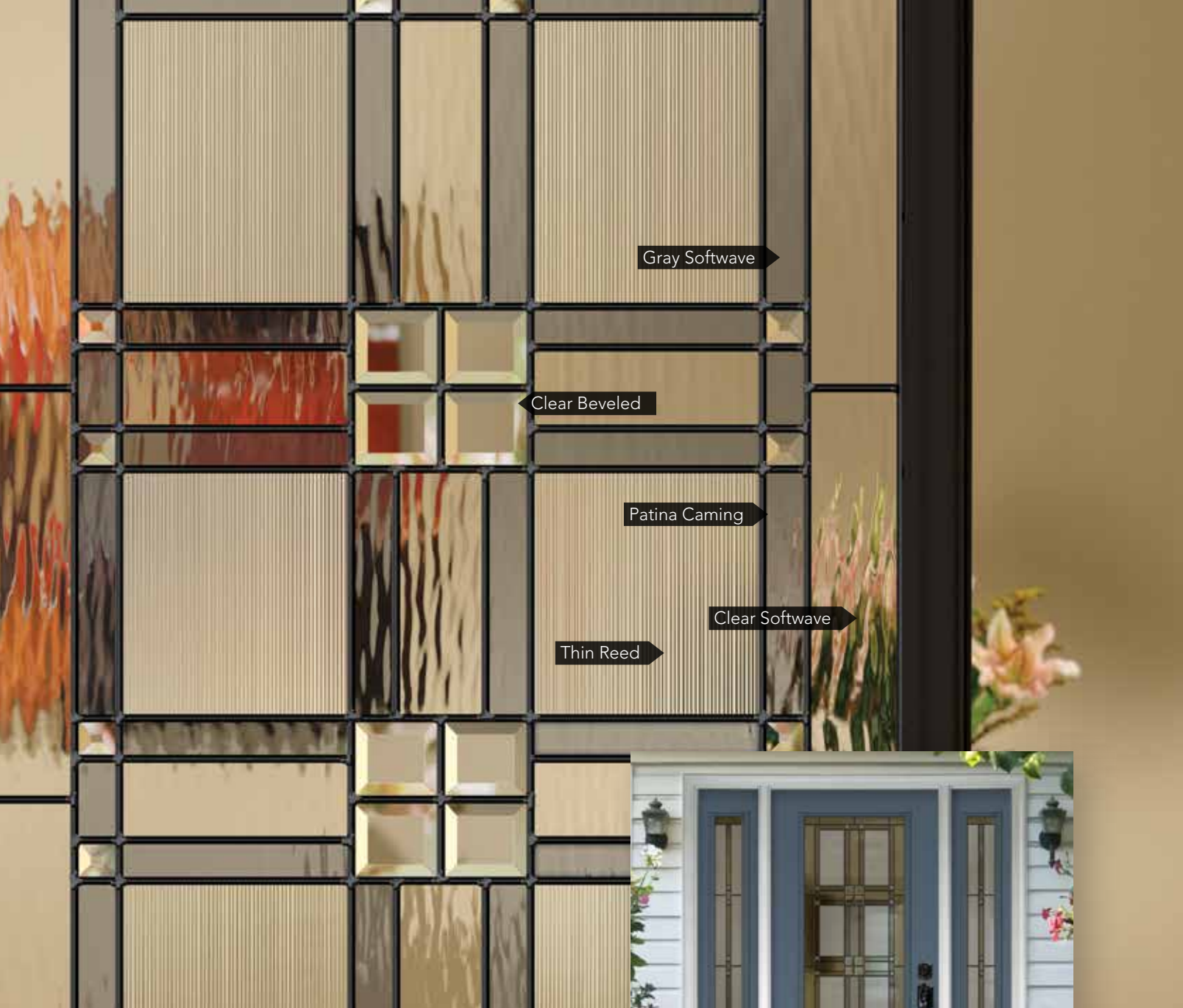

Gray Softwave

Clear Beveled

Patina Caming

Clear Softwave

Thin Reed



LAURENCE

DECORATIVE GLASS

Laurence features a gray softwave expressing defined classical vintage that will greet your guests with its distinguished character and prominent lines.

CAMING FINISH

Patina

PRIVACY RATING

1 2 3 4 5 **6** 7 8 9 10

less privacy

more privacy

LIFETIME LIMITED WARRANTY

Includes Glass Breakage & Seal Failure



All full wood frame and composite frame entry systems using Laurence Glass are ENERGY STAR® Certified and some steel L-Frame entry systems using Laurence Glass are ENERGY STAR Certified. See the ENERGY STAR section of our website for energy ratings on specific styles.



† For additional door panel styles see pg. 10 (for Embarq®), pg. 14 (for Signet®), pg. 16 (for Heritage™) or pg. 18 (for Legacy™)
 ‡ Requires an additional 6-week lead time
 † Cannot be mulled with Heritage Fiberglass doors in Certified Wind Load regions



CARRINGTON

DECORATIVE GLASS

Carrington features small hammered, flat seedy and clear bevels in an attractive vintage design to accent your home's entryway.

CAMING FINISH

Patina



PRIVACY RATING

1 2 3 4 **5** 6 7 8 9 10

less privacy more privacy

LIFETIME LIMITED WARRANTY

Includes Glass Breakage & Seal Failure



All full wood frame and composite frame entry systems using Carrington Glass are ENERGY STAR® Certified and some steel L-Frame entry systems using Carrington Glass are ENERGY STAR Certified. See the ENERGY STAR section of our website for energy ratings on specific styles.



Carrington Glass

§ Also available in 10" width (which requires an additional 4-week lead time). See Price List for design pattern
 † Requires an additional 6-week lead time

† For additional door panel styles see pg. 10 (for Embarq®), pg. 14 (for Signet®), pg. 16 (for Heritage™) or pg. 18 (for Legacy™)
 ✪ Cannot be mulled with Heritage Fiberglass doors in Certified Wind Load regions

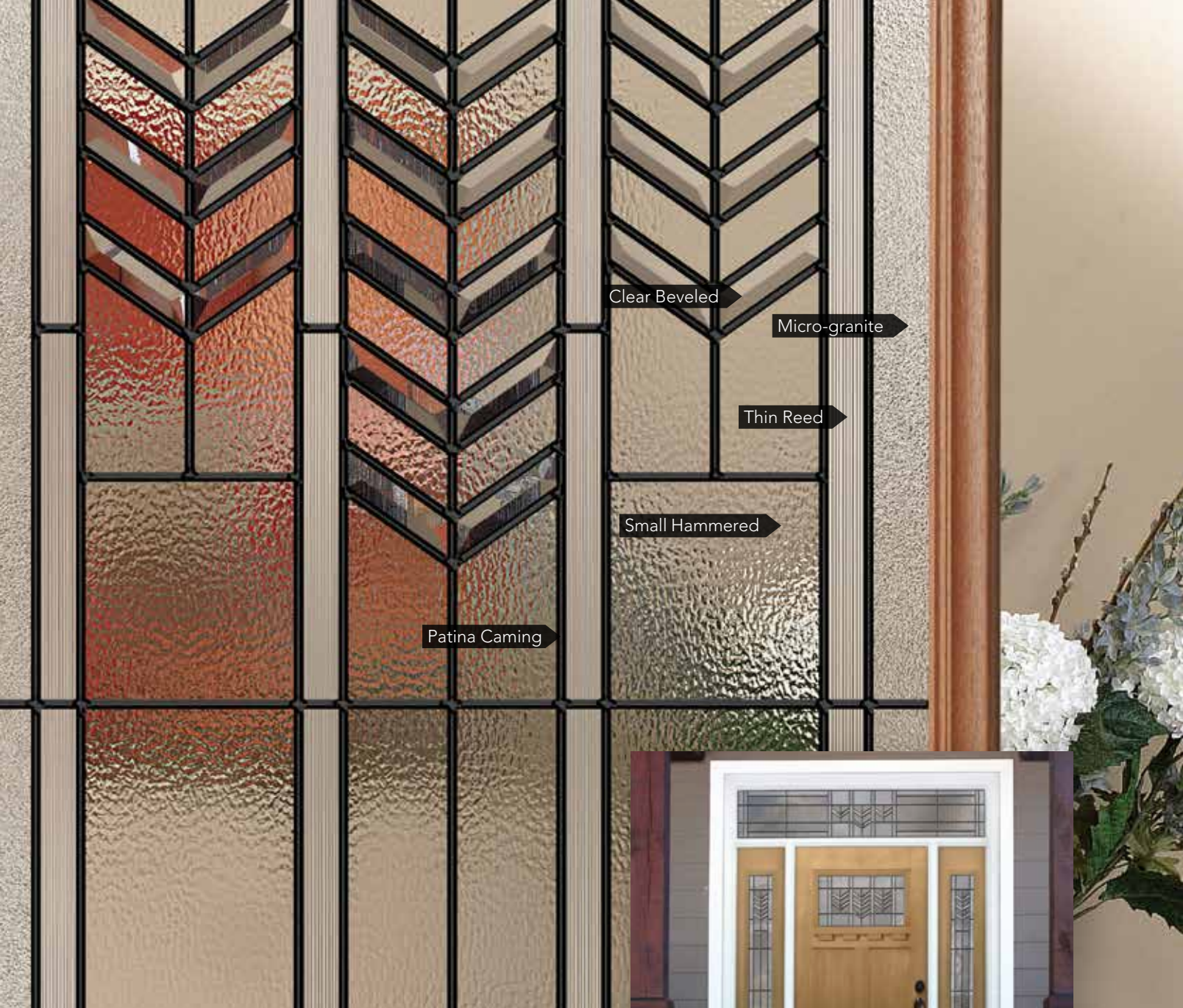

Clear Beveled

Micro-granite

Thin Reed

Small Hammered

Patina Caming



TACOMA

DECORATIVE GLASS

Tacoma features hammered and micro-granite design reminiscent of the Arts and Crafts period. Tacoma adds a southwestern inspired theme bringing heritage and legacy to your door.

CAMING FINISH

Patina

PRIVACY RATING

1 2 3 4 5 **6** 7 8 9 10

less privacy

more privacy

LIFETIME LIMITED WARRANTY

Includes Glass Breakage & Seal Failure



All full wood frame and composite frame entry systems using Tacoma Glass are ENERGY STAR® Certified and some steel L-Frame entry systems using Tacoma Glass are ENERGY STAR Certified. See the ENERGY STAR section of our website for energy ratings on specific styles.

612/613TAC☼†



160TAC 460TAC 160TAC



140TAC 440TAC† 140TAC

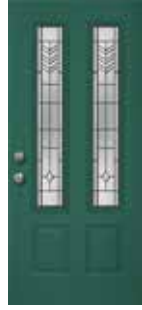

240TAC

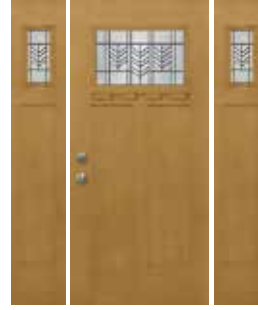

120TAC 420TAC-DS 120TAC



8' DOORS

440TAC† 140TAC 430TAC† 130TAC

† For additional door panel styles see pg. 10 (for Embarq®), pg. 14 (for Signet®), pg. 16 (for Heritage™) or pg. 18 (for Legacy™)
 ‡ Requires an additional 6-week lead time
 ☼ Cannot be mulled with Heritage Fiberglass doors in Certified Wind Load regions



Small Hammered

Zinc Caming

Micro-granite

Clear Beveled



SOMERSET

DECORATIVE GLASS

Somerset features small hammered, micro granite and clear bevels in a simple yet elegant design that gives a fresh look to your entryway.

CAMING FINISH



PRIVACY RATING

1 2 3 4 5 **6** 7 8 9 10

less privacy

more privacy

LIFETIME LIMITED WARRANTY

Includes Glass Breakage & Seal Failure



All full wood frame and composite frame entry systems using Somerset Glass are ENERGY STAR® Certified and some steel L-Frame entry systems using Somerset Glass are ENERGY STAR Certified. See the ENERGY STAR section of our website for energy ratings on specific styles.



§ Also available in 10" width. See Price List for design pattern
 ‡ Requires an additional 6-week lead time
 ‡ Cannot be mulled with Heritage Fiberglass doors in Certified Wind Load regions

† For additional door panel styles see pg. 10 (for Embarq®), pg. 14 (for Signet®) pg. 16 (for Heritage™) or pg. 18 (for Legacy™)

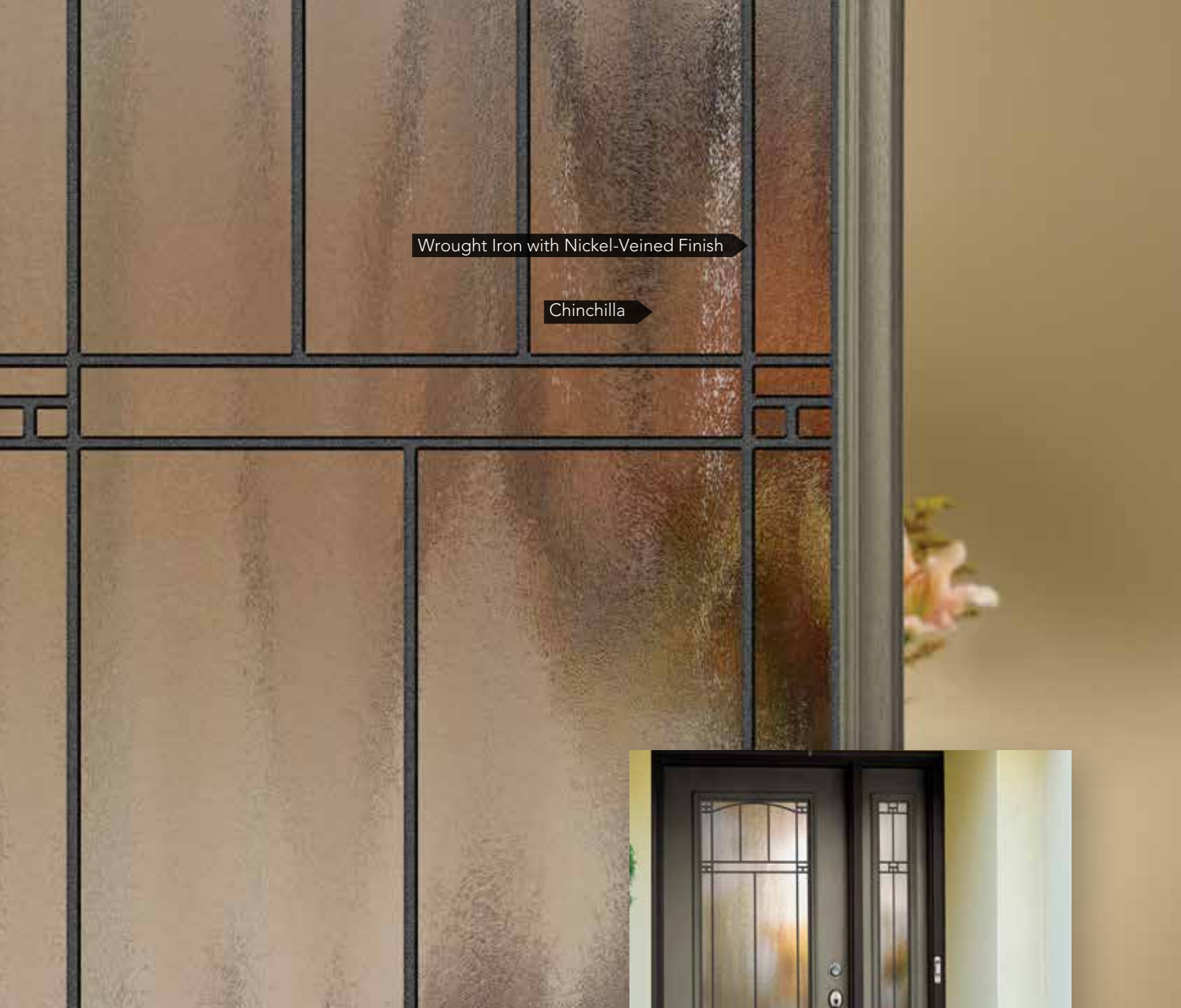

Wrought Iron with Nickel-Veined Finish

Chinchilla



CARMEN

DECORATIVE GLASS

Carmen features a refreshing new style for an entrance way with old world style charm. Standard with Chinchilla privacy glass and also available in all privacy glass options.

PRIVACY RATING

1 2 3 4 5 6 7 8 **9** 10

less privacy

more privacy

LIFETIME LIMITED WARRANTY

Includes Glass Breakage & Seal Failure



All full wood frame and composite frame entry systems using Carmen Glass are ENERGY STAR® Certified and some steel L-Frame entry systems using Carmen Glass are ENERGY STAR Certified. See the ENERGY STAR section of our website for energy ratings on specific styles.

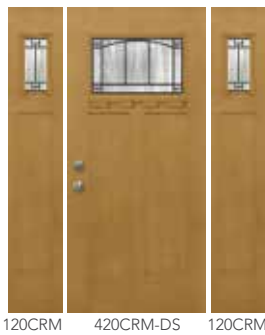
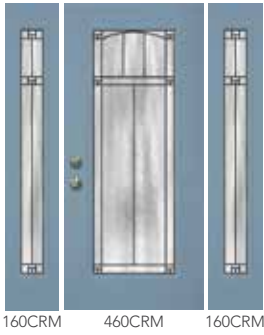

Carmen Glass

† For additional door panel styles see pg. 10 (for Embarq®), pg. 14 (for Signet®) pg. 16 (for Heritage™) or pg. 18 (for Legacy™)

When you order Carmen glass using the style code CRM, you will receive the standard Chinchilla glass. To order the other Privacy Glass options shown below, use the style codes GLC, TAF, WAT or OBS after the letters CRM (e.g. 460CRM-GLC).



GLUECHIP

PRIVACY RATING



less privacy more privacy



TAFFETA

PRIVACY RATING



less privacy more privacy



WATERFALL

PRIVACY RATING



less privacy more privacy



OBSCURE PEBBLE

PRIVACY RATING



less privacy more privacy



Black Wrought Iron

Gluechip



BARCELONA

DECORATIVE GLASS

Barcelona features an exquisite wrought iron design with the option of choosing gluechip (standard), waterfall, taffeta, chinchilla, obscure pebble or clear glass.

PRIVACY RATING

1 2 3 4 5 6 7 **8** 9 10

less privacy

more privacy

LIFETIME LIMITED WARRANTY

Includes Glass Breakage & Seal Failure



All Full Wood Frame and Composite Frame Entry Systems using Barcelona Glass are ENERGY STAR® Certified and some Steel L-Frame Entry Systems using Barcelona Glass are ENERGY STAR Certified. See the ENERGY STAR section of our website for energy ratings on specific styles.

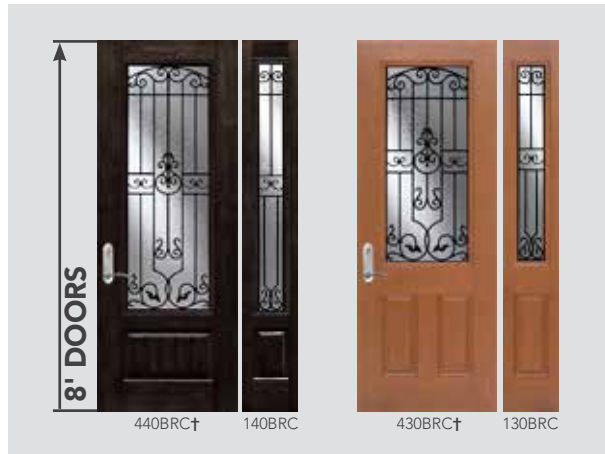

Barcelona Glass

† For additional door panel styles see pg. 10 (for Embarq®), pg. 14 (for Signet®) pg. 16 (for Heritage™) or pg. 18 (for Legacy™)

When you order Barcelona glass using the style code BRC, you will receive the standard Gluechip glass. To order the other Privacy Glass options shown below, use the style codes CHI, TAF, WAT or OBS after the letters BRC (e.g. 460BRC-CHI).

CHINCHILLA	TAFFETA	WATERFALL	OBSCURE PEBBLE
PRIVACY RATING	PRIVACY RATING	PRIVACY RATING	PRIVACY RATING
1 2 3 4 5 6 7 8 9 10	1 2 3 4 5 6 7 8 9 10	1 2 3 4 5 6 7 8 9 10	1 2 3 4 5 6 7 8 9 10
less privacy more privacy	less privacy more privacy	less privacy more privacy	less privacy more privacy



Caming

Gluechip

Beveled Edge Gluechip

Medium Gray Softwave



CONSTANCE

DECORATIVE GLASS

Constance features gluechip, medium gray softwave and beveled edge glue chip resulting in a traditional design that gives your entryway an elegant look.

CAMING FINISH



Brass



Zinc

Specify caming finish using these codes:
Brass - COB, Zinc - COZ

PRIVACY RATING

1 2 3 4 5 **6** 7 8 9 10

less privacy

more privacy

LIFETIME LIMITED WARRANTY

Includes Glass Breakage & Seal Failure



All full wood frame and composite frame entry systems using Constance Glass are ENERGY STAR® Certified and some steel L-Frame entry systems using Constance Glass are ENERGY STAR Certified. See the ENERGY STAR section of our website for energy ratings on specific styles.



Constance Glass

§ Also available in 10" width (which requires an additional 4-week lead time). See Price List for design pattern
† Requires an additional 6-week lead time

‡ For additional door panel styles see pg. 10 (for Embarq®), pg. 14 (for Signet®), pg. 16 (for Heritage™) or pg. 18 (for Legacy™)
§ Cannot be mulled with Heritage Fiberglass doors in Certified Wind Load regions



TRANQUILITY

DECORATIVE GLASS

Tranquility features unique Chinchilla glass accented with beveled clusters and streamed glass.

CAMING FINISH

Patina

Zinc

Specify caming finish using these codes:
Patina - TRP, Zinc - TRZ



PRIVACY RATING

1 2 3 4 5 6 7 **8** 9 10

less privacy

more privacy

LIFETIME LIMITED WARRANTY

Includes Glass Breakage & Seal Failure



All full wood frame and composite frame entry systems using Tranquility Glass are ENERGY STAR® Certified and some steel L-Frame entry systems using Tranquility Glass are ENERGY STAR Certified. See the ENERGY STAR section of our website for energy ratings on specific styles.

612/613TRP☼

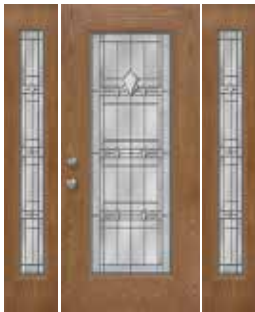
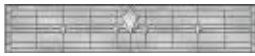

160TRP

460TRP

160TRP



140TRP

440TRP†

140TRP

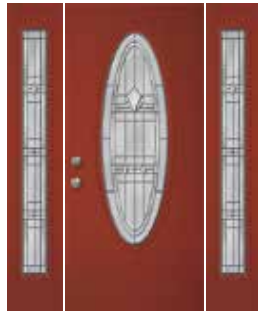

160TRP

350TRP

160TRP



150TRP†

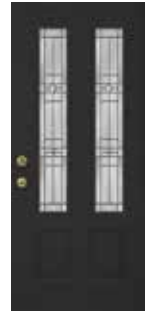

240TRP



243TRP



130TRP

430TRP†



230TRP



419TRP†



400TRP†



110TRP



8' DOORS

440TRZ†

140TRZ

430TRZ†

130TRZ

150TRP

† For additional door panel styles see pg. 10 (for Embarq®), pg. 14 (for Signet®), pg. 16 (for Heritage™) or pg. 18 (for Legacy™)

‡ Requires an additional 6-week lead time

☼ Cannot be mulled with Heritage Fiberglass doors in Certified Wind Load regions

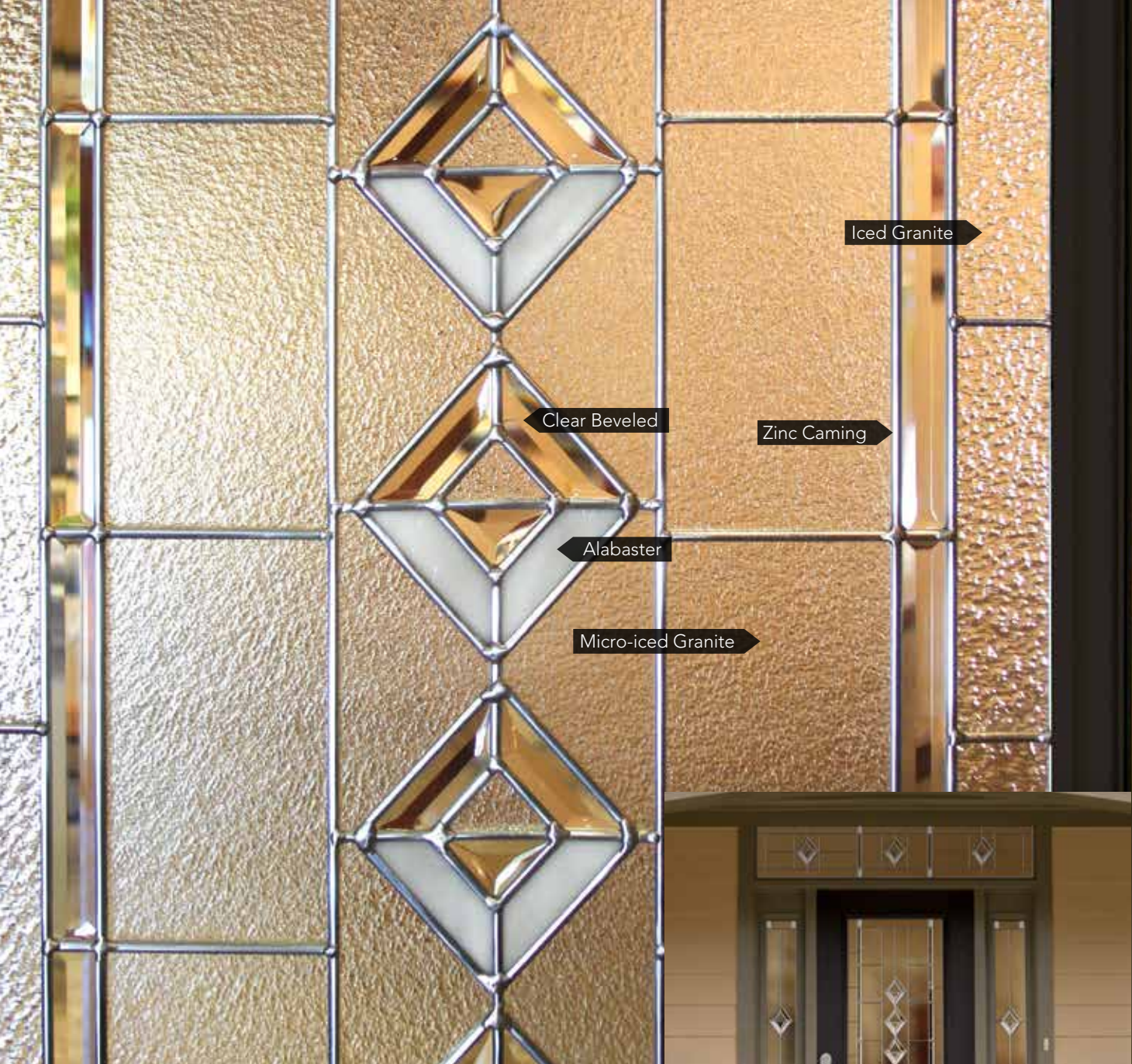

Iced Granite

Clear Beveled

Zinc Caming

Alabaster

Micro-iced Granite



GEMSTONE

DECORATIVE GLASS

Beautiful beveled glass with iced and micro-iced granite, accented with zinc caming, gives this classic design a contemporary edge.

CAMING FINISH



PRIVACY RATING

1 2 3 4 5 6 7 **8** 9 10

less privacy

more privacy

LIFETIME LIMITED WARRANTY

Includes Glass Breakage & Seal Failure



All full wood frame and composite frame entry systems using Gemstone Glass are ENERGY STAR® Certified and some steel L-Frame entry systems using Gemstone Glass are ENERGY STAR Certified. See the ENERGY STAR section of our website for energy ratings on specific styles.



160GEM 460GEM† 160GEM



140GEM 440GEM† 140GEM



150GEM†



240GEM



243GEM

Gemstone Glass



130GEM 430GEM†



230GEM



419GEM†



† For additional door panel styles see pg. 10 (for Embarq®), pg. 14 (for Signet®), pg. 16 (for Heritage™) or pg. 18 (for Legacy™)

‡ Requires an additional 6-week lead time

⊛ Cannot be mulled with Heritage Fiberglass doors in Certified Wind Load regions



ECLIPSE

DECORATIVE GLASS

Eclipse features double gluechip and clusters of bevel with a traditional and harmonious design. Eclipse promotes classical elegance and privacy.

CAMING FINISH



Specify caming finish using these codes:
 Brass - ECB, Zinc - ECZ, Patina - ECP

PRIVACY RATING

1 2 3 4 5 6 **7** 8 9 10

less privacy

more privacy

LIFETIME LIMITED WARRANTY

Includes Glass Breakage & Seal Failure



All full wood frame and composite frame entry systems using Eclipse Glass are ENERGY STAR® Certified and some steel L-Frame entry systems using Eclipse Glass are ENERGY STAR Certified. See the ENERGY STAR section of our website for energy ratings on specific styles.



† For additional door panel styles see pg. 10 (for Embarq®), pg. 14 (for Signet®), pg. 16 (for Heritage™) or pg. 18 (for Legacy™)
 ‡ Requires an additional 6-week lead time
 ✪ Cannot be mulled with Heritage Fiberglass doors in Certified Wind Load regions



FLORENCE

DECORATIVE GLASS

This traditional style is accented with a creamy alabaster glass adding interest and appeal that clearly sets it apart from other decorative designs.

CAMING FINISH

Brass

Patina

Specify caming finish using these codes:
Brass - FLB, Patina - FLP

PRIVACY RATING

1 2 3 4 5 6 7 **8** 9 10

less privacy

more privacy

LIFETIME LIMITED WARRANTY

Includes Glass Breakage & Seal Failure



All full wood frame and composite frame entry systems using Florence Glass are ENERGY STAR® Certified and some steel L-Frame entry systems using Florence Glass are ENERGY STAR Certified. See the ENERGY STAR section of our website for energy ratings on specific styles.

612/613FLP†



160FLP

460FLP

160FLP



140FLP

440FLP†

140FLP



160FLP

350FLP

160FLP



150FLP†



240FLP



243FLP



130FLP

430FLP†



230FLP



419FLP†



400FLP†



Florence Glass

† For additional door panel styles see pg. 10 (for Embarq®), pg. 14 (for Signet®), pg. 16 (for Heritage™) or pg. 18 (for Legacy™)

‡ Requires an additional 6-week lead time

⚠ Cannot be mulled with Heritage Fiberglass doors in Certified Wind Load regions

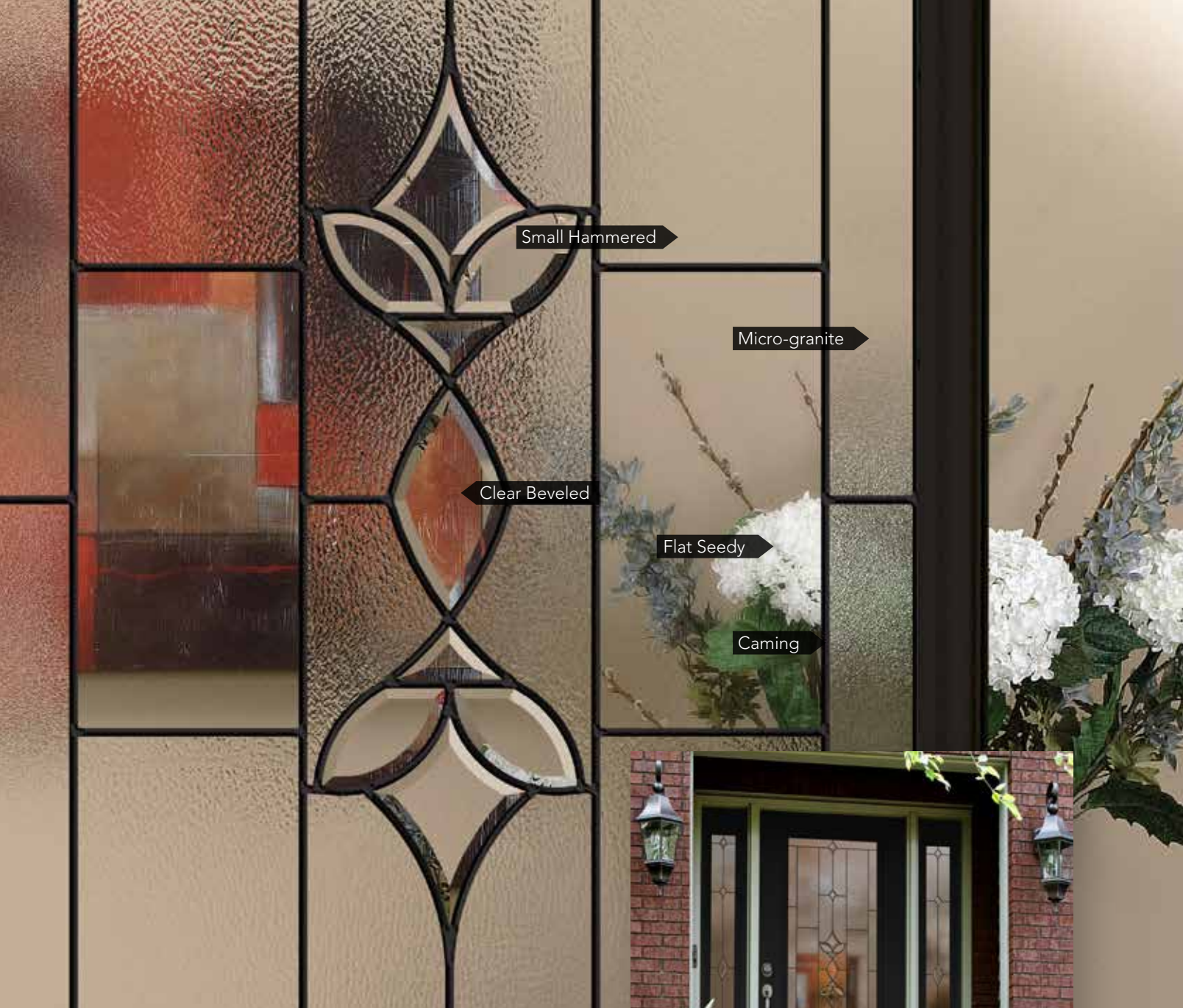

ESMOND

DECORATIVE GLASS

Esmond features small hammered, micro-granite, flat seedy and clear bevels in a splendid old-world style design bringing a unique touch to your entryway.

CAMING FINISH

Patina

PRIVACY RATING

1 2 3 4 5 **6** 7 8 9 10

less privacy

more privacy

LIFETIME LIMITED WARRANTY

Includes Glass Breakage & Seal Failure



All full wood frame and composite frame entry systems using Esmond Glass are ENERGY STAR® Certified and some steel L-Frame entry systems using Esmond Glass are ENERGY STAR Certified. See the ENERGY STAR section of our website for energy ratings on specific styles.



Esmond Glass

§ Also available in 10" width (which requires an additional 4-week lead time). See Price List for design pattern
 † Requires an additional 6-week lead time

‡ For additional door panel styles see pg. 10 (for Embarq®), pg. 14 (for Signet®), pg. 16 (for Heritage™) or pg. 18 (for Legacy™)
 ☼ Cannot be mulled with Heritage Fiberglass doors in Certified Wind Load regions

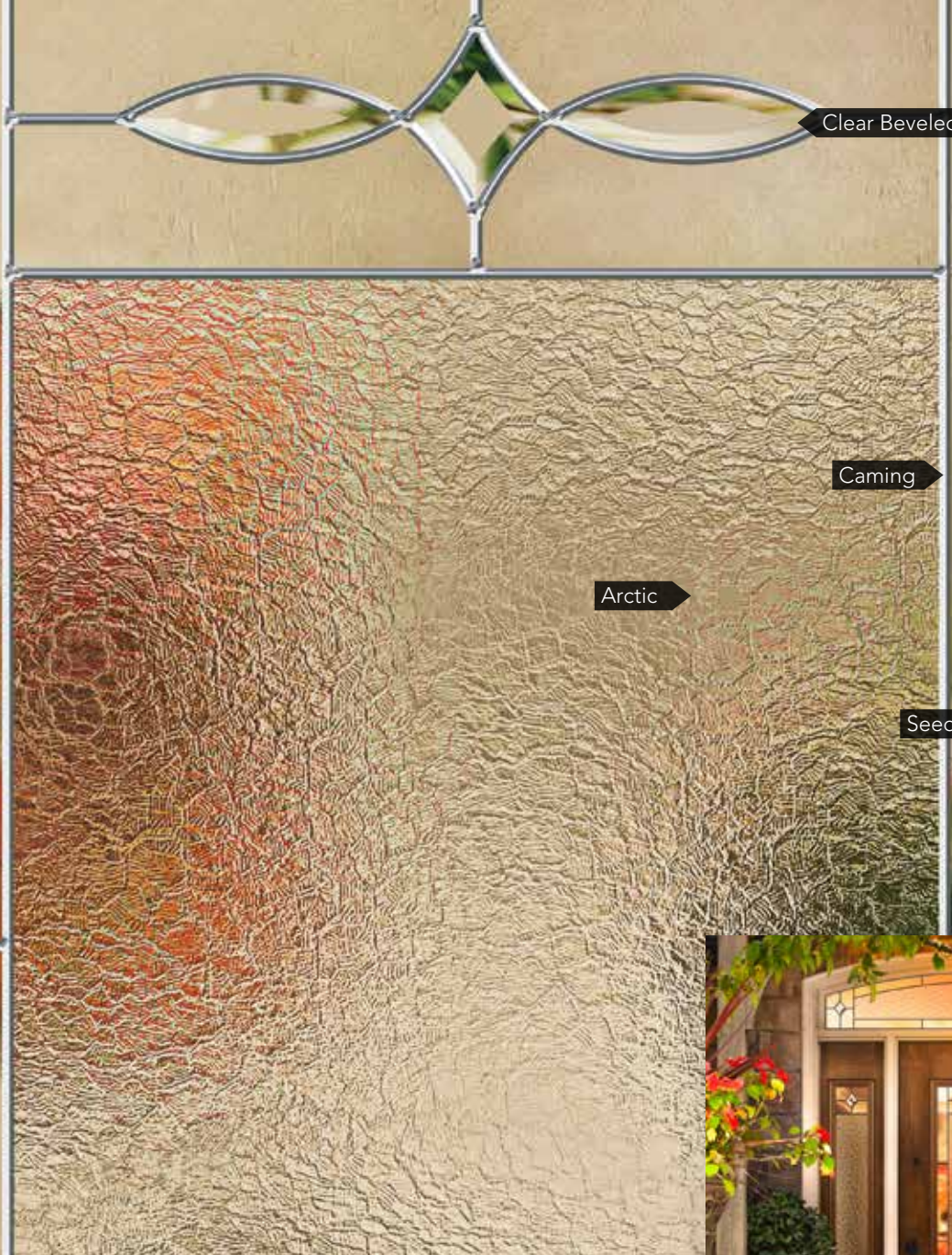

CARLISLE

DECORATIVE GLASS

Carlisle features clear bevels, arctic and seedy glass giving an appealing entrance way to any style of home.

CAMING FINISH



Specify caming finish using these codes:
Patina - CRP, Zinc - CRZ

PRIVACY RATING

1 2 3 4 5 6 **7** 8 9 10

less privacy

more privacy

LIFETIME LIMITED WARRANTY

Includes Glass Breakage & Seal Failure



All full wood frame and composite frame entry systems using Carlisle Glass are ENERGY STAR® Certified and some steel L-Frame entry systems using Carlisle Glass are ENERGY STAR Certified. See the ENERGY STAR section of our website for energy ratings on specific styles.



§ Also available in 10" width (which requires an additional 4-week lead time). See Price List for design pattern
 † Requires an additional 6-week lead time

‡ For additional door panel styles see pg. 10 (for Embarq®), pg. 14 (for Signet®), pg. 16 (for Heritage™) or pg. 18 (for Legacy™)
 § Cannot be mullied with Heritage Fiberglass doors in Certified Wind Load regions



TWILIGHT

DECORATIVE GLASS

Twilight is a beautifully decorative silk-screened art. It's unique frosted glass adds to the warmth and privacy of your home.



PRIVACY RATING

1 2 3 4 5 6 7 **8** 9 10

less privacy

more privacy

LIFETIME LIMITED WARRANTY

Includes Glass Breakage & Seal Failure



All full wood frame and composite frame entry systems using Twilight Glass are ENERGY STAR® Certified and some steel L-Frame entry systems using Twilight Glass are ENERGY STAR Certified. See the ENERGY STAR section of our website for energy ratings on specific styles.



160TWI 350TWI 160TWI

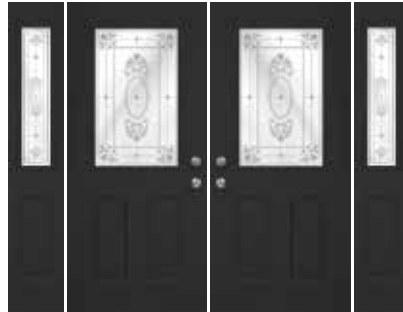

130TWI 430TWI† 430TWI† 130TWI



130TWI 230TWI



400TWI†



160TWI 110TWI 160TWI

† For additional door panel styles see pg. 10 (for Embarq®), pg. 14 (for Signet®), pg. 16 (for Heritage™) or pg. 18 (for Legacy™)





INSPIRATIONS™

ART GLASS

A ProVia® exclusive, Inspirations Art Glass allows you to do just what the name suggests-let your doors reflect the inspiration of your imagination with your choice of design and color.

DESIGNS

The process begins with conceptual design. Our beautiful Inspirations Art Glass styles originated from the imagination of our in-house designers.

RESIN BEAD

The design pattern is created on our computer software, and sent to a CNC machine which applies a resin bead to the surface of the glass in one of our four stylish colors.

COLOR FILL

The color fill truly brings the glass to life. Several colors are offered empowering you to perfectly reflect the personality of you and your home. Our craftsmen hand-apply this color fill to your glass.

OUR GUARANTEE

The resin bead and color fill are backed by our Lifetime Limited Warranty, and will not fade, blister or peel away from the glass.





SEE MORE INSPIRATIONS

Ask to see our Inspirations Art Glass brochure for available styles and color palettes, or use our ProVia app to create custom color palettes and design your dream door.



Download our free app today!



Download on entryLINK
or provia.com/app



CHINCHILLA (CHI)

PRIVACY RATING



less privacy more privacy



TAFFETA (TAF)

PRIVACY RATING



less privacy more privacy



WATERFALL (WAT)

PRIVACY RATING

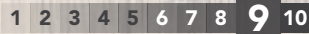

less privacy more privacy



GLUECHIP (GLC)

PRIVACY RATING



less privacy more privacy



OBSCURE PEBBLE (OBS)

PRIVACY RATING



less privacy more privacy



PRIVACY GLASS

Privacy glass allows light to filter in, while keeping a high level of privacy.

LIFETIME LIMITED WARRANTY

Includes Glass Breakage & Seal Failure

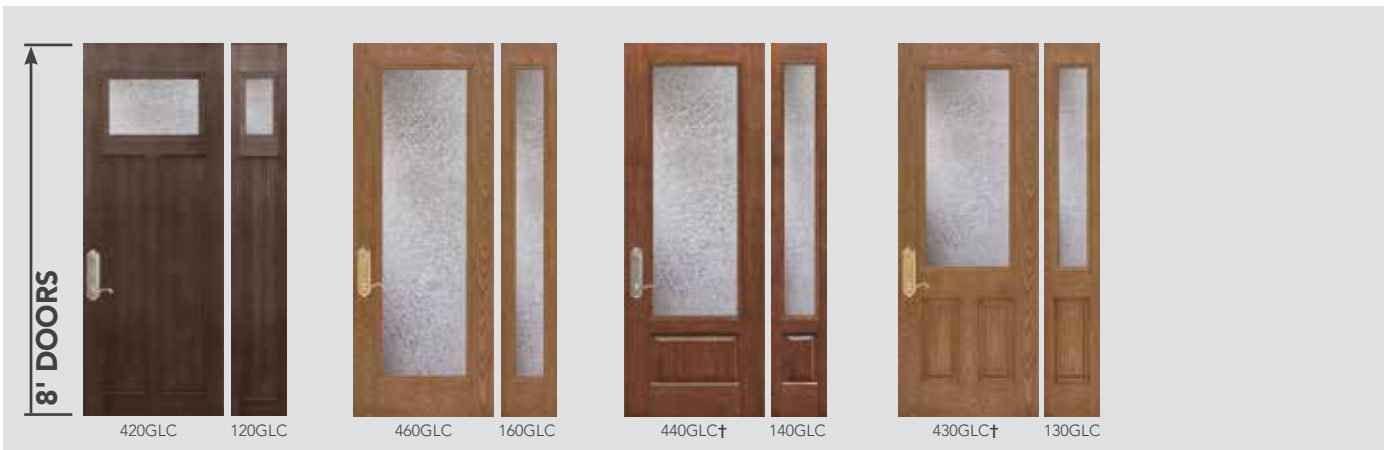



Door Styles	Glazing Systems			
	TLK	TLA	DLA	DC
HALF-LITE OR LARGER				
460, 449, 440, 437, 430, 439, 240, 239, 230, 112, 114, 115, 116	●	●	●	●
SMALLER THAN HALF-LITE				
420, 419, 400, 243, 110	●	●	●	●

ENERGY STAR Certified
Refer to pg. 28-89 for Glazing Systems information

Since Low-E glass has a slight color tint, it is recommended that sidelites are ordered with the same glazing system as the door.



- † For additional door panel styles see pg. 10 (for Embarq®), pg. 14 (for Signet®), pg. 16 (for Heritage™) or pg. 18 (for Legacy™)
- § Also available in 10" width.
- ✱ Cannot be milled with Heritage Fiberglass doors in Certified Wind Load regions
- ◆ Only available with Modern Flat Glass Trim. Only available with 770 sidelite(s) or 160 sidelite(s) with Modern Flat Glass Trim.

Note - Privacy glass is available in Simulated Divided Lites (see pg. 86) Simulated Divided Panels (pg. 88) and External Grids (see pg 93).



CLEAR GLASS

LIFETIME LIMITED WARRANTY
Includes Glass Breakage & Seal Failure

Clear Glass is appropriate on every entry of your home and can still be energy efficient.

Door Styles	Glazing Systems			
	TLK	TLA	DLA	DC
HALF-LITE OR LARGER 460, 449, 440, 439, 437, 430, 350, 240, 239, 230, 150, 112, 114, 115, 116	●	●	●	●
SMALLER THAN HALF-LITE 420, 419, 400, 243, 110	●	●	●	●
306, 206, 131, 101, 100				●



All entry systems with Clear Glass can be ENERGY STAR® Certified depending on the glazing system you choose. This chart indicates which glazing system is required for ENERGY STAR certification, as well as availability.

- ENERGY STAR Certified
Refer to pg. 28-29 for Glazing Systems information

Since Low-E glass has a slight color tint, it is recommended that sidelites are ordered with the same glazing system as the door.



TRANSOMS



460DC

160DC

440DC†

140DC

113

612/613DC⊕ pg. 100

512/513DC⊕ pg. 101

532DC* pg. 105

516DC* pg. 105

616DC⊕ pg. 104

712/713DC⊕ pg. 100



449DC†

770DC⊕§

439DC†

139DC

437DC†

430DC†

130DC

430DC-F†

350DC

243DC

240DC

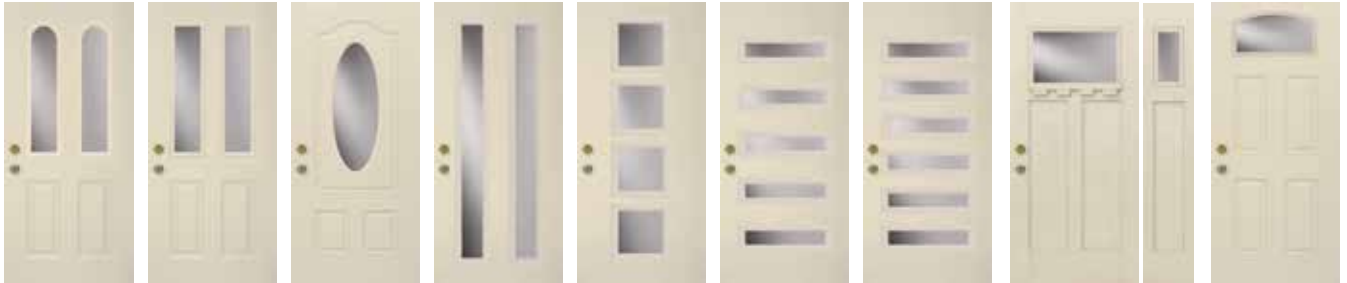

239DC

230DC

150DC†

112DC◆

114DC◆

115DC◆

116DC◆

420DC-D5†

120DC

419DC†



400DC†

306DC

206DC

106DC

131DC

110DC

101DC

100DC

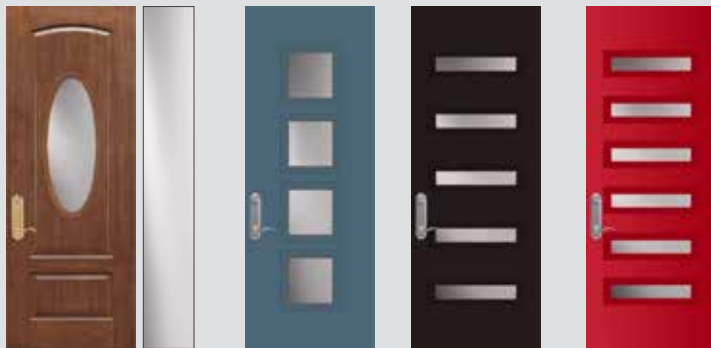

150DC-1P

770DC§

114DC◆

115DC◆

116DC◆

§ Also available in 10" width.

† For additional door panel styles see pg. 10 (for Embarq®), pg. 14 (for Signet®), pg. 16 (for Heritage™) or pg. 18 (for Legacy™)

⊕ Cannot be mulled with Heritage Fiberglass doors in Certified Wind Load regions

★ In Certified Wind Load region, indicated transoms must be installed in a separate opening or use approved engineering mulls

◆ Only available with Modern Flat Glass Trim. Only available with 770 sidelite(s) or 160 sidelite(s) with Modern Flat Glass Trim.

Note - Clear glass is available in Simulated Divided Lites (see pg. 86) Simulated Divided Panels (see pg. 88) Internal Grids (see pg. 90) (and External Grids (see pg 93).



Blind operator as viewed from the interior of your home.

WHITE INTERNAL BLINDS

Internal blinds are constructed with sturdy white aluminum and enclosed in tempered safety glass. Easy to clean; no more dusting of blinds. Internal Blinds are suitable for entry doors, sidelites and patio doors and carry a 20-Year Warranty.

FEATURES

- Ergo Track on glass
- Eliminated Slat/Privacy Channel Gap
- U-Privacy Channels (side, top & bottom) eliminate light gaps, shadows and sunlight glare
- Full Tilt Closure (top to bottom) allows the blinds to tilt completely closed keeping unwanted light out



All entry systems with Internal Blinds can be ENERGY STAR® Certified depending on the glazing system you choose. This chart indicates which glazing system is required for ENERGY STAR certification, as well as availability.

Door Styles		
INTERNAL BLINDS	DLA	DC
With Internal Grids	●	●
INTERNAL BLINDS		
Without Grids	●	●

ENERGY STAR Certified
Refer to pg. 28-29 for Glazing Systems information

Since Low-E glass has a slight color tint, it is recommended that sidelites are ordered with the same glazing system as the door.

WITH **TRADITIONAL** (COLONIAL) INTERNAL GRIDS



WITH **PRAIRIE** INTERNAL GRIDS



WITH **COTTAGE** INTERNAL GRIDS



BLINDS **WITHOUT** INTERNAL GRIDS



Internal Blinds

† For additional door panel styles see pg. 14 (for Signet®), pg. 16 (for Heritage™) or pg. 18 (for Legacy™)
 * On Signet doors, blind operator will be operator pictured on page 90

COLORED INTERNAL BLINDS

Internal blinds are available in four neutral hues to complement any room in the house. Easy to clean; no more dusting of blinds. Internal blinds are suitable for entry doors and patio doors. Offering a 10-Year Warranty.



Blind operator as viewed from the interior of your home.

AVAILABLE COLORS

Cream

Tan

Silver

Champagne

(require additional lead time)

**colors not available in sidelites*



All entry systems with Internal blinds can be ENERGY STAR® Certified depending on the glazing system you choose. This chart indicates which glazing system is required for ENERGY STAR certification, as well as availability.

BLINDS **WITHOUT** INTERNAL GRIDS



460BLR



440BLR†



430BLR†

WITH **TRADITIONAL (COLONIAL)** INTERNAL GRIDS



460BLR-IGTA



440BLR-IGT†Δ



430BLR-IGT†Δ

WITH **PRAIRIE** INTERNAL GRIDS



460BLR-IGPA



440BLR-IGP†Δ



430BLR-IGP†Δ

WITH **COTTAGE** INTERNAL GRIDS



460BLR-IGCA



440BLR-IGC†Δ



430BLR-IGC†Δ

† For additional door panel styles see pg. 14 (for Signet®), pg. 16 (for Heritage™) or pg. 18 (for Legacy™)
 Δ Not available in Signet Series



Colored Blinds

SIMULATED DIVIDED LITES

Simulated Divided Lites (SDL) are reminiscent of old world craftsmanship when separate pieces of glass were mullied together with wooden grids. We deliver that same stunning appearance through our high-tech stained fiberglass 1" wide x 1¹/₃₂" thick grids combined with the energy efficient qualities of our ComforTech glass packages.



CRAFTSMAN

Only available for Signet Fir Series



CONTOURED

Available for all styles shown, except for Signet Fir Series



BEVELED GLASS

The beauty of beveled glass and coming combine for a distinguished take on traditional divided lights.

Each piece of beveled glass is secured with coming for the beautiful look of a true divided light, with the efficiency of a single doorlight.





† For additional door panel styles see pg. 10 (for Embarq®), pg. 14 (for Signet®)
 ▲ Requires plugless trim

Δ Not Available with beveled glass



All entry systems with Simulated Divided Lites can be ENERGY STAR® Certified depending on the glazing system you choose. This chart indicates which glazing system is required for ENERGY STAR certification, as well as availability.

Note - All doors and sidelites with SDL's are available with privacy glass.
 Note - SDL's match stain or paint of door.

(See pages 10-21 for Impact Shield & Windload availability)

NEW

SIMULATED DIVIDED PANELS

For a stylish and modern look, Simulated Divided Panel fiberglass doors feature wider SDL's (3" and/or 5") applied to the surface of glass on a 460 style Fir door or directly onto the skin of a 001 style Fir door. Numerous configurations and endless paint, glaze or stain colors allow you to create a door design that is contemporary, sophisticated and on-trend.

Note - Available only in Signet® Fir with Clear glass (see pg. 80) or Privacy glass (see pg. 78)
Simulated Divided Panel designs can not be customized

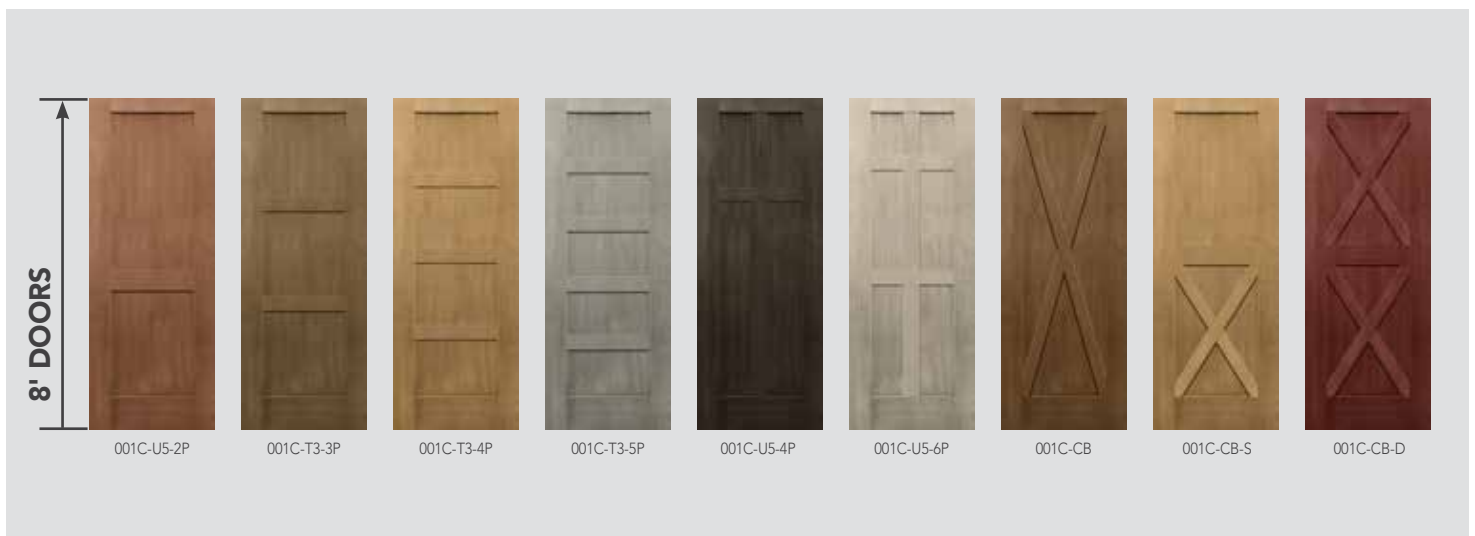



460-C5 160-C5 460-T3-3L 160-T3-3L 460-T5-4L 160-T5-4L 460-T3-5L 160-T3-5L 460-T3-6L 160-T3-6L 460-UM-7L 160-UM-7L



460-T5-8L 460-M3 001C-U5-2P 001C-T3-3P 001C-T3-4P 001C-T3-5P 001C-U5-4P



001C-U5-6P 001C-CB 001C-CB-S 001C-CB-D

Simulated Divided Panels

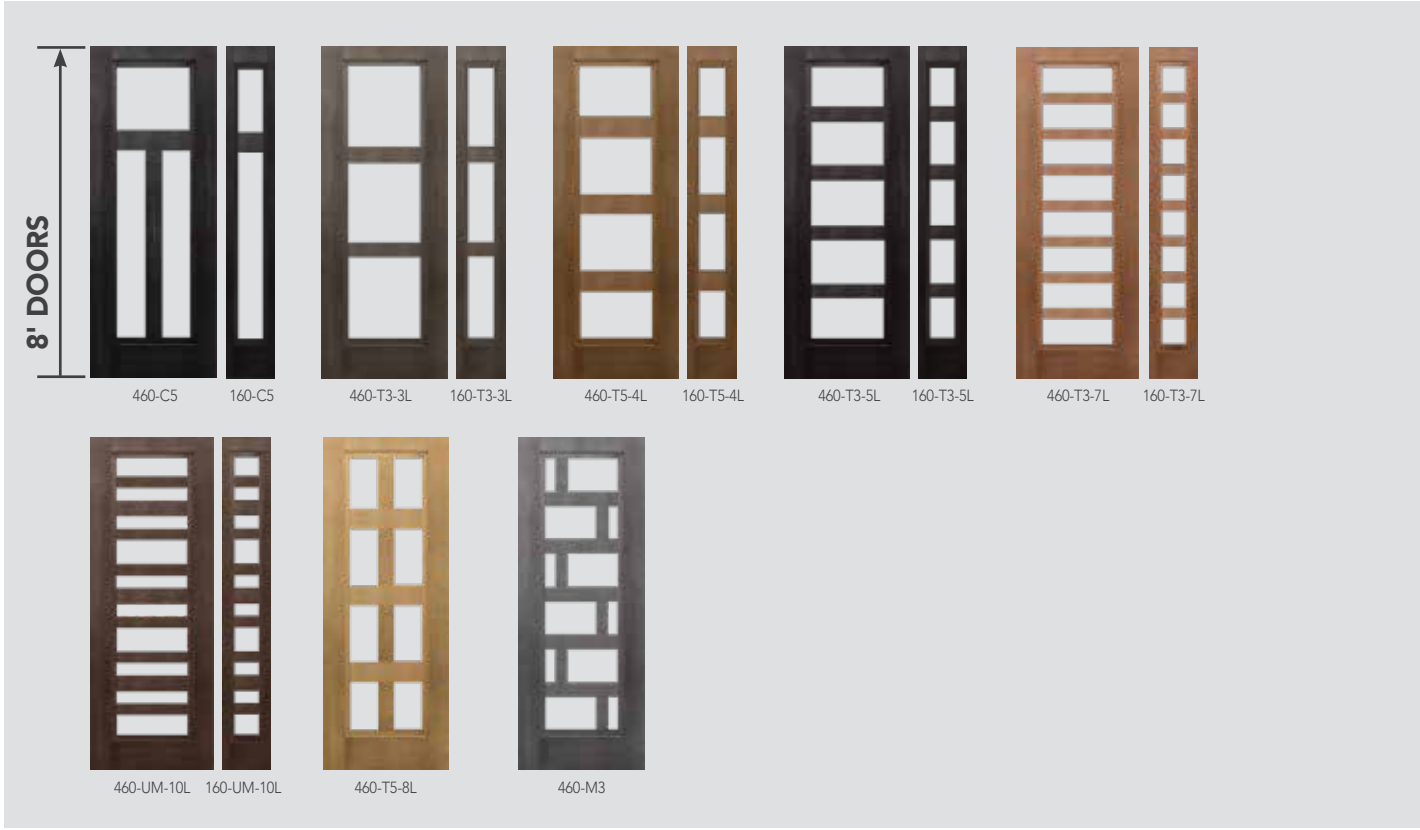



INTERNAL GRIDS OPTIONS

Note: Pencil Grids are not available in Prairie Grids on some indicated doors and transoms

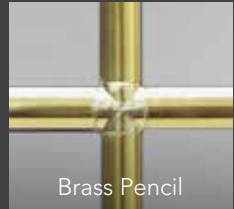

Brass Pencil

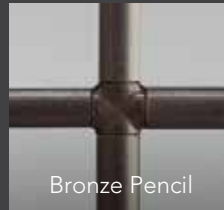

Bronze Pencil



Satin Nickel Pencil

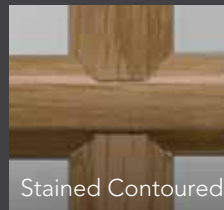

Stained Contoured



Painted Contoured

INTERNAL GRIDS

CONTOURED GRID COLORS AND STAINS

Snow Mist	Café Cream	Sandpiper Beige	Sandstone	Clay	Forest Green	Mountain Berry	Rustic Bronze
Tudor Brown	Coal Black†	Honey Wheat† & Light Oak†	American Cherry† & Cherry†				

TWO-TONE CONTOURED GRIDS

Snow Mist	Snow Mist	Snow Mist	Snow Mist	Snow Mist	Snow Mist	Snow Mist
Café Cream	Sandpiper Beige	Sandstone	Forest Green	Mountain Berry	Coal Black†	Honey Wheat† & Light Oak†
Snow Mist	Snow Mist	Snow Mist	Sandpiper Beige	Sandpiper Beige	Sandpiper Beige	Sandpiper Beige
Almond† & Dark Oak†	American Cherry† & Cherry†	Toffee† & Traditional Cherry†	Honey Wheat† & Light Oak†	Almond† & Dark Oak†	American Cherry† & Cherry†	Toffee† & Traditional Cherry†
Sandstone	Sandstone	Sandstone	Sandstone			
Honey Wheat† & Light Oak†	Almond† & Dark Oak†	American Cherry† & Cherry†	Toffee† & Traditional Cherry†			

460 STYLES
 IGP N/A in Pencil Grids
 IGC
 IGC-TS

160 STYLES
 IGP N/A in Pencil Grids
 IGC
 IGC-TS

440 STYLES
 IGP N/A in Pencil Grids
 IGC†

140 STYLES
 IGC
 IGP N/A in Pencil Grids

430 STYLES
 IGP†
 IGC†
 IGC-TS

130 STYLES
 IGP
 IGC
 IGC-TS

230 STYLES
 IGP
 IGC

240 STYLES
 IGP N/A in Pencil Grids
 IGC

449 STYLES
 IGP† N/A in Pencil Grids
 IGC†

770 STYLES
 IGP‡§
 IGC‡§
 N/A in Pencil Grids

437 STYLES
 IGP† N/A in Pencil Grids
 IGC†

420DS STYLES
 IGC-DS†
 IGP-DS†
 IGC-DS†

120 STYLES
 IGC
 IG4

420 STYLES
 IGC†
 IGP†
 IGC†

 All entry systems with Internal Grids can be ENERGY STAR® Certified depending on the glazing system you choose. This chart indicates which glazing system is required for ENERGY STAR certification, as well as availability.

Door Styles	Glazing Systems		
	TLA	DLA	DC
HALF-LITE OR LARGER			
460, 440, 430, 240, 230	●	●	●
430, 440 Heritage Fiberglass only	●	●	●
449, 437		●	●
SMALLER THAN HALF-LITE			
420, 419, 400	●	●	●

 ENERGY STAR Certified
 Refer to pg.28-29 for Glazing Systems information

Since Low-E glass has a slight color tint, it is recommended that sidelites are ordered with the same glazing system as the door.

§ Also available in 10" width.
 ** Requires an additional 4-week lead time
 † For additional door panel styles see pg. 10 (for Embarq®), pg. 14 (for Signet®), pg. 16 (for Heritage™) or pg. 18 (for Legacy™)
 ‡ Cannot be mullied with Heritage Fiberglass doors in Certified Wind Load regions
 * In Certified Wind Load region, indicated transoms must be installed in a separate opening or use approved engineering mulls

INTERNAL GRIDS CONT'D

TRANSOMS



512/513DC-IGS
Not available in Pencil Grids



612/613DC-IGS
Not available in Pencil Grids



532DC-IGS*



616DC-IGT



516DC-IGS*



612/613DC-IGT



712/713DC-IGS**



616DC-IGP

Not available in Pencil Grids

8' DOORS

440DC-SDT†

440 STYLES

IGP†
N/A in Pencil Grids

IGC†

IGT†

IGC†-TS

140 STYLES

IGC

IGP

IGC-TS

N/A in Pencil Grids

§ Also available in 10" width.
** Requires an additional 4-week lead time
† For additional door panel styles see pg. 10 (for Embarq®), pg. 14 (for Signet®), pg. 16 (for Heritage™) or pg. 18 (for Legacy™)
* Cannot be milled with Heritage Fiberglass doors in Certified Wind Load regions
* In Certified Wind Load region, indicated transoms must be installed in a separate opening or use approved engineering mulls

8' DOORS

430DC-IGP†

N/A in Pencil Grids

430 STYLES

IGT†

IGC†

130 STYLES

IGT

IGC

420DC-IGT-DSt

120DC-IGT

420DS STYLES

*IG6-DSt

*IG2-DSt

*IGC-DSt

120 STYLES

IGC

IG4

*available with or without dental shelf.

8' DOORS

437DC-IGP†

N/A in Pencil Grids

437 STYLES

IGT†

IGC†

770 STYLES

IGT§

460DC-IGC

160DC-IGC

460 STYLES

IGT

160 STYLES

IGT

EXTERNAL GRIDS

LIFETIME LIMITED WARRANTY
Includes Glass Breakage & Seal Failure



External grids will match the door's paint or stain color.

Note: All doors with external grids (except for 410 style) are available with privacy glass.

† For additional door panel styles see pg.16 (for Heritage™) or pg. 18 (for Legacy™)
Δ Not available in 1" warm edge. Also, Glass trim screw plugs are not available for this door style.



All entry systems with External Grids can be ENERGY STAR® Certified depending on the glazing system you choose. This chart indicates which glazing system is required for ENERGY STAR certification, as well as availability.

Door Styles	Glazing Systems			
	TLK	TLA	DLA	DC
HALF-LITE OR LARGER				
460, 430, 439, 230	●	●	●	●
SMALLER THAN HALF-LITE				
410				●
400	●	●	●	●

● ENERGY STAR Certified
Refer to pg. 28-29 for Glazing Systems information

Since Low-E glass has a slight color tint, it is recommended that sidelites are ordered with the same glazing system as the door.

STAIN FINISHES

Applied with care, by professionals. If you buy an entry system and finish it yourself, chances are it's the first door you've ever painted or stained. At ProVia®, stains are hand-applied by professional craftsmen, many who have been perfecting their work for years.



EMBARQ® & SIGNET®

7-STEP STAIN FINISHING SYSTEM



1. **DURAFUSE™** - Proprietary P³ Fusion Preparation Processes ensuring unprecedented finish durability
2. **HAND-APPLIED STAIN FINISH** formulated exclusively for Signet fiberglass doors
3. A layer of 2-part urethane, catalyst-hardened **CLEAR COAT WITH UV INHIBITORS** is applied
4. Clear coat is **OVEN-CURED** for lasting durability
5. The door is **HAND-SANDED**, preparing the surface for the second layer of clear coat
6. A second layer of 2-part urethane, catalyst-hardened **CLEAR COAT WITH UV INHIBITORS** is applied
7. The door is **OVEN-CURED** a second time, creating a long-lasting, durable finish

Cherry & Mahogany Stains (shown on Cherry)

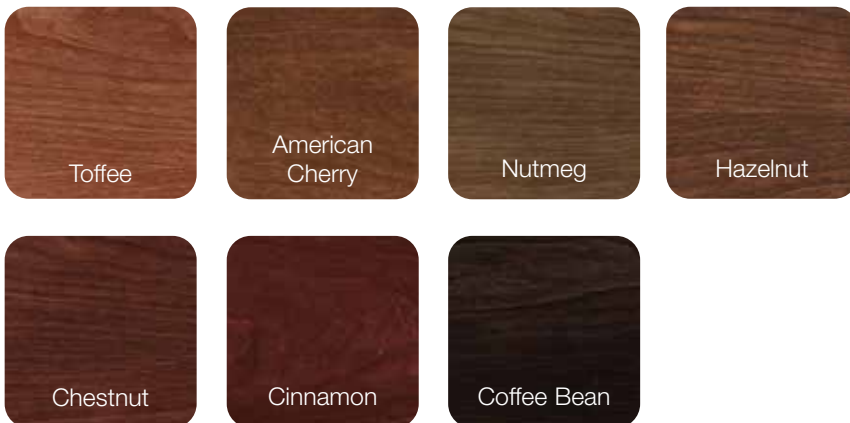

Oak, Knotty Alder & Fir Stains (shown on Oak)

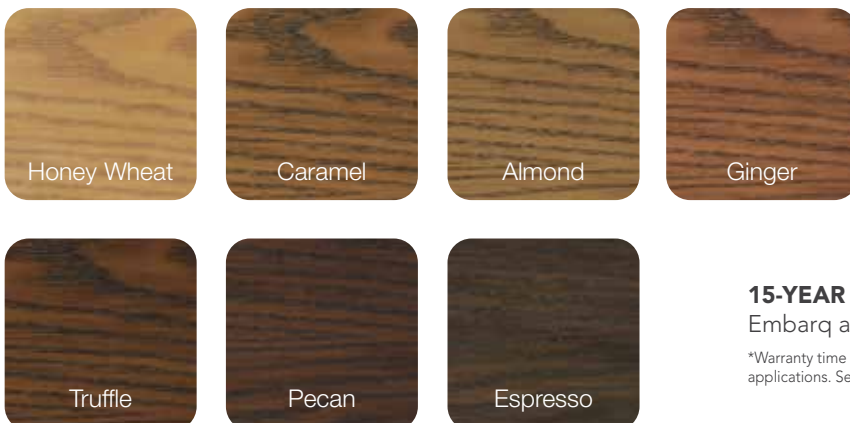

15-YEAR FINISH WARRANTY*

Embarq and Signet Fiberglass

*Warranty time period may be limited in extreme exposure applications. See warranty for details.

Always refer to our color selector for accurate color representation.

EMBARQ® & SIGNET® GLAZED FINISHES

Distinctive beauty achieved through a creative hand-applied finish giving each door a unique aged look.

9-STEP GLAZED FINISHING SYSTEM



1. **DURAFUSE™** - Proprietary P³ Fusion Preparation Processes ensuring unprecedented finish durability
2. A 2-part urethane, catalyst-hardened **BASE COAT** (prime paint) is applied
3. Base coat is **OVEN-CURED** for lasting durability
4. **HAND-APPLIED STAIN FINISH** formulated exclusively for Signet fiberglass doors
5. A layer of 2-part urethane, catalyst-hardened **CLEAR COAT WITH UV INHIBITORS** is applied
6. Clear coat is **OVEN-CURED** for lasting durability
7. The door is **HAND-SANDED**, preparing the surface for the second layer of clear coat
8. A second layer of 2-part urethane, catalyst-hardened **CLEAR COAT WITH UV INHIBITORS** is applied
9. The door is **OVEN-CURED** a second time, creating a long-lasting, durable finish

Knotty Alder, Mahogany, Fir, Cherry & Oak Glazed Finishes (Shown on Oak)



15-YEAR FINISH WARRANTY*

Embarq and Signet Fiberglass

*Warranty time period may be limited in extreme exposure applications. See warranty for details.

Always refer to our color selector for accurate color representation.

HERITAGE™ & LEGACY STEEL™

LEGACY

6-STEP STAIN FINISHING SYSTEM



1. Steel doors are **A40 Hot-dipped Galvannealed** (300% more coating thickness than 40Z full electrolytic zinc coated steel) to resist rust inside and out
2. A 2-part urethane, catalyst-hardened **BASE COAT** (prime paint) is applied by a robotic reciprocating paint system
3. Base coat is **OVEN-CURED** for lasting durability
4. **HAND-APPLIED STAIN FINISH** is added for enhanced beauty
5. A layer of 2-part urethane, catalyst-hardened **CLEAR COAT WITH UV INHIBITORS** is applied
6. The door is **OVEN-CURED** a second time, creating a long-lasting, durable finish

HERITAGE

5-STEP STAIN FINISHING SYSTEM



1. A 2-part urethane, catalyst-hardened **BASE COAT** (prime paint) is applied by a robotic reciprocating paint system
2. Base coat is **OVEN-CURED** for lasting durability
3. **HAND-APPLIED STAIN FINISH** is added for enhanced beauty
4. A layer of 2-part urethane, catalyst-hardened **CLEAR COAT WITH UV INHIBITORS** is applied
5. The door is **OVEN-CURED** a second time, creating a long-lasting, durable finish

Heritage & Legacy Stains (shown on Oak)

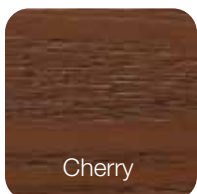

10-YEAR FINISH WARRANTY*

Heritage and Legacy Doors

*Warranty time period may be limited in extreme exposure applications. See warranty for details.

Always refer to our color selector for accurate color representation.

PAINT FINISHES

We do the finishing, so you don't have to.

You wouldn't try to paint a car yourself, so why should it be any different when it comes to staining or painting your entry door?



LEGACY

5-STEP PAINT FINISHING SYSTEM

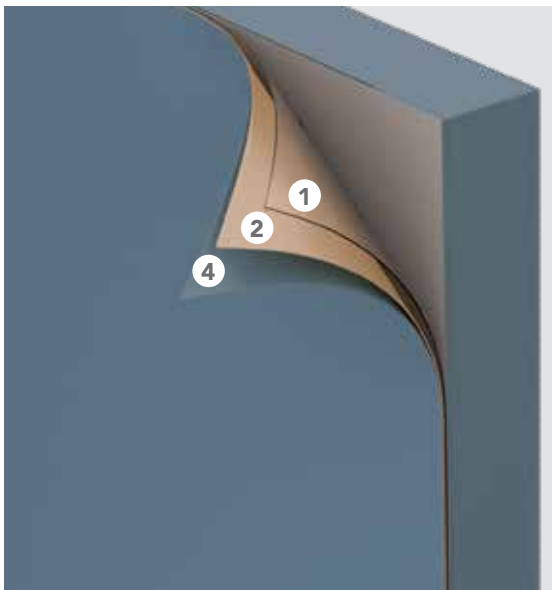

1. Steel doors are **A40 Hot-dipped Galvannealed** (300% more coating thickness than 40Z full electrolytic zinc coated steel) to resist rust inside and out
2. A 2-part urethane, catalyst-hardened **BASE COAT** (prime paint) is applied by a robotic reciprocating paint system
3. Base coat is **OVEN-CURED** for lasting durability
4. The door is then coated with a 2-part urethane, catalyst-hardened **FINISH COAT**
5. The door is **OVEN-CURED** a second time, creating a long-lasting, durable finish

HERITAGE

4-STEP PAINT FINISHING SYSTEM



1. A 2-part urethane, catalyst-hardened **BASE COAT** (prime paint) is applied by a robotic reciprocating paint system
2. Base coat is **OVEN-CURED** for lasting durability
3. The door is then coated with a 2-part urethane, catalyst-hardened **FINISH COAT**
4. The door is **OVEN-CURED** a second time, creating a long-lasting, durable finish

10-YEAR FINISH WARRANTY*

Heritage and Legacy Doors

*Warranty time period may be limited in extreme exposure applications. See warranty for details.

EMBARQ[®], SIGNET[®], HERITAGE[™] & LEGACY[™] STEEL PAINT FINISHES

EMBARQ AND SIGNET

5-STEP PAINT FINISHING SYSTEM

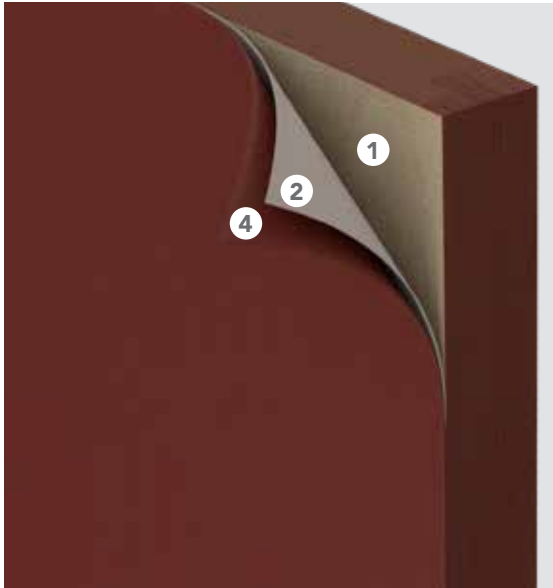

1. **DURAFUSE[™]** - Proprietary P³ Fusion Preparation Processes ensuring unprecedented finish durability
2. A 2-part urethane, catalyst-hardened **BASE COAT** (prime paint) is applied by a robotic reciprocating paint system
3. Base coat is **OVEN-CURED** for lasting durability
4. The door is then coated with a 2-part urethane, catalyst-hardened **FINISH COAT**
5. The door is **OVEN-CURED** a second time, creating a long-lasting, durable finish

15-YEAR FINISH WARRANTY*

Embarq and Signet Fiberglass

*Warranty time period may be limited in extreme exposure applications. See warranty for details.



Always refer to our color selector for accurate color representation.

TRENDING COLORS

Color trends are always changing. ProVia's color palette has been completely refreshed to give you even more paint color options for your entry doors, patio doors and storm doors.

All of our traditional hues have been categorized and new "trending" colors have been added, creating three very distinct color palettes to suite your taste: Natural Instincts, Freshly Picked and Stately Shades.

Trending colors
AVAILABLE
on Storm Doors



FRESHLY PICKED PAINT FINISHES



Hibiscus



Avocado

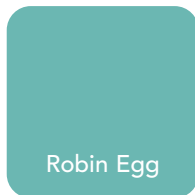

Robin Egg



Blueberry



Plum

STATELY SHADES PAINT FINISHES



Moss



Clover



Deep Blue



Cabernet



Burnt Orange



Goldenrod



Always refer to our color selector for accurate color representation.

CUSTOM PAINT COLORS



Still searching for the perfect color?

Custom color-matching is also available on our Entry Doors, Aeris Patio Doors, Endure Patio Doors (exterior only) and Storm Doors.

Custom stains also available on Signet Fiberglass and Aeris Patio Doors.

Additional lead-time required.



HARDWARE

We offer a variety of designs and finishes, from angular to flowing, classic to contemporary, all with their own security features, unique functionality, and advanced technology. You'll be sure to find the features and design that will ensure your front door is the perfect complement to your new entryway.





TRILENNIUM[®] MULTI-POINT

HARDWARE

The Trilennium Multi-Point locking system provides more than just security. It offers homeowners better door closure and sealing than a single point lock.

- Three 1" deadbolts latch with deadbolt throw
- Deadbolts include anti-saw hardened steel pin.
- A solid I-beam runs the full length of the lock, and increases the strength and precision of the lock.
- Latch and deadbolt release with a single downward movement.



Top and bottom latch design allows for door misalignment and $\frac{3}{16}$ " pull-in when deadbolted.

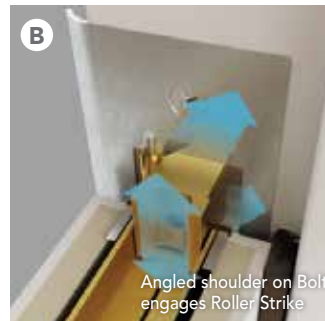

ECLIPSE



Trilennium hardware is required on all 8' Signet® and Heritage™ fiberglass doors. Optional on all other fiberglass doors.

Also available on all 20-gauge Legacy steel doors.

NOT available on Steel L-Frames

Trilennium hardware has a 10-Year warranty on materials and workmanship.

Trilennium hardware is NOT available on French Doors in Certified Wind Load or Impact Shield regions.

PINNACLE (Not available in Black Finish)



TRILENNIUM HARDWARE IS AVAILABLE IN THESE FINISHES

Lifetime Bright Brass

Lifetime Satin Nickel

Lifetime Flat Bronze*

Lifetime Black

* Flat Bronze does not coordinate with Black/Bronze accessories.

Lifetime finish warranty time period is limited to five years if product is installed in a coastal region.

WESTCOTT (Not available in Bright Brass Finish)



HOPPE® MULTI-POINT

HARDWARE

Hoppe Multi-Point hardware offers the additional security of four points of latching when the door is locked, and the easy operation of one point of latching when the door is unlocked.

- Stainless Steel and other non-corrosive components.
- Anti-Back Drive prevents locking points from disengaging from the outside for added security.
- Latch Blocker on inactive systems will not allow multipoint activation until inactive system is activated.
- Lock Out Feature on interior system allows for multipoint activation from the exterior of the door by lifting handle.
- Backplate and cylinder housing are forged into one piece for improved appearance and easier installation.
- Simultaneous retraction feature enables all locking points to be retracted by pushing down on the inside handle.

HOPPE HARDWARE IS AVAILABLE IN THESE FINISHES

Lifetime Bright Brass

Lifetime Satin Nickel

(Hoppe hardware is NOT tested for Certified Wind Load or Impact Shield regions)

Lifetime finish warranty time period is limited to five years if product is installed in a coastal region.

*Not available on steel I-frames, patio units, and french doors

EXTERIOR STYLES



New Orleans Contemporary Arch



New Orleans Classic Arch

INTERIOR STYLES



New Orleans Contemporary Arch



New Orleans Classic Arch

MULTI-POINT LOCKING

(Lock body faceplate is only available in stainless steel)

A
Three Point Deadbolt lock is engaged by lifting handle upward

B
Handleset latch

TO LOCK:
Step 1: Turn thumbturn ¼ turn counterclockwise

Step 2: Lift handle upward

A detailed diagram of the multi-point locking mechanism. It shows a vertical metal bar with several locking points. A handle is attached to the bar. A thumbturn is located on the handle. Blue arrows and labels 'A' and 'B' indicate the locking points and the handle's movement. A blue curved arrow indicates the thumbturn's rotation.



EMTEK's Mortise hardware features the added advantages and options that come with push-button controls.

- Push-button passage controls
For more passage and locking options
- Heavy-duty Forged Brass Construction - *For long lasting beauty*
- Solid Brass Nose Bolts on Latches - *For dependable use*
- Lifetime Mechanical Warranty
Our guarantee of value
- Lifetime Anti-tarnish Finish
Warranty - Beauty for life

Push button passage controls provide added security and peace of mind. When the upper button is pressed in, the mortise lock is only accessible by using a key.

To activate the Passage Function, push in the lower button. This will allow you to access the thumb latch without a key.

Note: As long as the Passage Function is NOT engaged, the door will lock automatically when latched, and will not allow entry without a key.

EMTEK MORTISE HARDWARE IS AVAILABLE IN THESE FINISHES

Lifetime Bright Brass

NEW

Lifetime Satin Brass

Lifetime Satin Nickel

Lifetime Oil Rubbed Bronze

Lifetime Black

(EMTEK Mortise hardware is NOT tested for Certified Wind Load or Impact Shield regions)

Lifetime finish warranty time period is limited to five years if product is installed in a coastal region.

(EMTEK Mortise hardware is only available for Signet Fiberglass and 20-gauge steel doors)

EMTEK[®] MORTISE

HARDWARE

▶ See video at provia.com/provia-videos for features and operation

EXTERIOR STYLES



Craftsman • Δ



Memphis •



Manhattan • Δ



NEW Adelaide Δ

INTERIOR STYLES



Oval Beaded
Egg •
(Recommended
on Memphis)



Hammered
Lever Δ•
(Recommended
on Craftsman)



Coventry Lever •
(Recommended
on Memphis)



Square Knob • Δ
(Recommended on
Manhattan)



NEW Helios Lever Δ
(Recommended on
Adelaide)

Δ Not available in Bright Brass
• Not available in Satin Brass



EMTEK's unique Interconnect Device provides the security of a locking deadbolt while providing the means for a panic-proof exit. Turning the interior knob or lever simultaneously retracts both the deadbolt and passage latches.

- Heavy-duty forged brass construction - *For long lasting beauty*
- Durable springs to prevent lever sag
- Threaded brass tubes solid brass nose bolts on latches
- Lifetime mechanical warranty *our guarantee of value*
- Lifetime anti-tarnish finish warranty - *Beauty for life*

EMTEK HARDWARE
IS AVAILABLE IN THESE
FINISHES

- Lifetime Bright Brass
- NEW** Lifetime Satin Brass
- Lifetime Satin Nickel
- Lifetime Oil Rubbed Bronze
- Lifetime Black

Lifetime finish warranty time period is limited to five years if product is installed in a coastal region.

EMTEK[®]
HARDWARE

EXTERIOR STYLES
(Single Point Lock)



Melrose Δ



Marietta Δ



Orleans • ◇



NEW Davos Δ

MODERN RECTANGULAR
(Two Point Lock)

Panic-proof exit not available in Modern Rectangular hardware



Round Knob Δ



Hanover Lever Δ

INTERIOR STYLES

(Any interior handle can be used with any exterior handle)



Egg Δ
(Recommended on Melrose)



Egg Δ
(Recommended on Marietta)



Cortina • ◇
(Recommended on Orleans)



NEW Stuttgart Δ
(Recommended on Davos)



Round Knob Δ



Hanover Lever Δ

Δ Not available in Bright Brass
• Not available in Satin Brass
◇ Not available in Black



BRINKS® PUSH PULL ROTATE

HARDWARE

Brinks' Home Security Push Pull Rotate Knobs and Levers are the easiest, most comfortable way to open a door. With just one finger, an elbow, or your hip, you can simply push or pull your way through a door. Great if you have your hands full or free!

**BRINKS
HARDWARE IS
AVAILABLE IN THESE
FINISHES**

10-Year Satin Nickel

10-Year Aged Bronze

Finish warranty time period is limited to five years if product is installed in a coastal region.



PUSH IT



PULL IT



ROTATE IT



EXTERIOR STYLES



Anderson with
Brynne Deadbolt*



Harper Lever with
Almarion Deadbolt



Stafford Knob with
Almarion Deadbolt*



INTERIOR STYLES



Harper Lever with
Celia Deadbolt



Harper Lever with
Almarion Deadbolt



Stafford Knob with
Almarion Deadbolt*



EXTERIOR / INTERIOR AVAILABLE COMBINATIONS

Exterior Handles	Interior Levers and Knobs	
	Harper Lever	Stafford Knob
Anderson	•	
Harper	•	
Stafford		•

*not available for outswing doors



SCHLAGE® VINTAGE

HARDWARE

Schlage Vintage hardware offers you much more than just great looks. Look to Schlage for hardware that looks great and lasts.

- Solid Cast Brass
For long lasting beauty
- Maximum Security Deadbolt
For peace of mind
- Nickel Silver Pins and Keys
For smooth, reliable operation
- Heavy Duty Springs
For durable and "droop-free" levers
- Superior Parts and Design
Tested for over 400,000 cycles of operation
- Lifetime Mechanical Warranty
Our guarantee of value
- Lifetime Anti-tarnish Finish Warranty
Beauty for life

SCHLAGE VINTAGE HARDWARE IS AVAILABLE IN THESE FINISHES

Lifetime Bright Brass

Lifetime Satin Nickel

Lifetime Antique Brass

Lifetime Black

Lifetime finish warranty time period is limited to five years if product is installed in a coastal region.

EXTERIOR STYLES



Addison*

Camelot

Plymouth

INTERIOR STYLES



Georgian

Accent

Flair

Accent/Addison*

* Not available in Bright Brass finish



SCHLAGE® ELECTRONIC KEYPADS



SCHLAGE SENSE™ SMART DEADBOLT

The Schlage Sense Smart Deadbolt makes daily life easier and more convenient. Enter an access code on the touchscreen to unlock the door instead of searching your pockets for keys. Pairing the lock with your smartphone over Bluetooth® is as easy as pairing your phone with your car, and the free Schlage Sense app makes setting up and using the lock as simple as checking email. Share access with trusted friends and family with just a few taps – no more keeping track of spare keys.



Camelot Trim



Lifetime Satin Nickel

Lifetime Black



Century Trim



Lifetime Satin Nickel

Lifetime Black

ELECTRONIC DEADBOLT

ELECTRONIC KEYPAD DEADBOLT



Exterior

Interior

ACCENT LEVER ELECTRONIC LOCKSET



Exterior

Interior

Electronic locksets and deadbolts utilize Schlage's Innovative keyless access. It's convenient and is customizable to fit your security needs.

- Deadbolt is available with any Schlage entry hardware
- 9-volt battery included
- Lighted keypad
- Up to 19 user codes
- Easy to add or delete codes
- Lifetime Mechanical and 3-Year Electronics Warranty

AVAILABLE FINISHES

Lifetime Bright Brass

Lifetime Satin Nickel

Lifetime Antique Brass

Lifetime Black

Lifetime finish warranty time period is limited to five years if product is installed in a coastal region. Antique Brass finish is NOT available.

SCHLAGE® CLASSIC HARDWARE

Schlage Classic hardware can fill your needs when you desire something understated, yet beautiful and lasting. Choose from an assortment of finishes.

SCHLAGE CLASSIC HARDWARE FINISHES

Lifetime Bright Brass

Lifetime Satin Nickel

Lifetime Antique Brass

Lifetime Black

Lifetime finish warranty time period is limited to five years if product is installed in a coastal region.

Antique Brass finish is NOT available.

SCHLAGE CLASSIC DOOR LOCKSETS AND DEADBOLTS



Accent/Addison
Keyed Lockset*



Accent Keyed
Lockset



Exterior Interior
Georgian Key in
Knob Lockset



Flair Keyed
Lockset



Latitude Lever with Century
Trim Keyed Lockset §



Latitude Lever with Collins
Trim Keyed Lockset ‡



Addison Trim *



Exterior Interior
Maximum Security
Double Key
1" Deadbolt ◊



Interior Only 1-Sided
Thumbturn 1" Deadbolt ◊
(Only available in 20-Gauge
Steel or Signet Fiberglass)



Century Trim §



Thumbturn 1"
Deadbolts

◊ Interior Only 1-Sided Thumbturn Deadbolts on any door which is used for egress may be a safety hazard in times of emergency. Double Key Deadbolts on any door which is used for egress are a safety hazard in times of emergency.

* Not available in Bright Brass finish

‡ Only available in Satin Nickel finish

§ Only available in Satin Nickel and Lifetime Black finish

SCHLAGE PASSAGE LATCHES



Accent/Addison
Passage Latch*



Accent
Passage Latch



Latitude Lever with
Century Trim §



Latitude Lever
with Collins Trim ‡



Flair
Passage Latch



Georgian
Passage Latch

OPTIONAL ACCESSORIES

Sometimes the smallest things make the biggest difference. Our accessories add a lot to the look of your entry system.



Colonial Door Knocker



Classic Door Knocker



Classic Door Knocker/Viewer



Mail Slot or Magazine Slot*
(NOT tested for Certified Wind Load or Impact Shield regions)
(Doors with Mail Slot or Magazine Slot are not ENERGY STAR® certified)



1/8" Peepsite**



Kick Plate

Decorative Hinges

Also available in Satin Nickel & Oil Rubbed Bronze (Inswing only)

NOT tested for Impact Shield regions.



Steeple



Ball

FINISHES

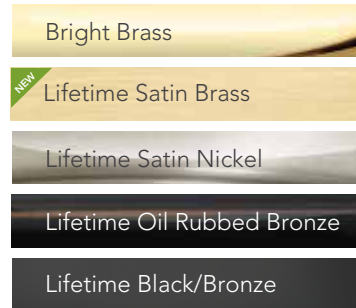

ACCESSORIES FINISH AVAILABILITY 5-Year Mechanical Warranty

Accessories	Lifetime Finish				5-Year Finish		No Finish Warranty	Impact Shield 5-Year Finish
	Bright Brass	Satin Brass	Satin Nickel	Black/Bronze	Bright Brass	Antique Brass	Oil Rubbed Bronze	Bright Brass, Satin Nickel, Black/Bronze and Satin Brass
Colonial Door Knocker	•		•				•	• (N/A Black/Bronze)
Classic Door Knocker/Viewer	•	•	•	•	•	•		•
Classic Door Knocker	•	•	•	•	•	•		•
Magazine Slot*	•	•	•	•	•	•		
Mail Slot*	•	•	•	•	•	•		
Kick Plate	•	•	•	•	•	•		•

* Mail slot and magazine slot are not available on 003C, 006C, 008P, 009, 420-DS, 420-2P, 420-3P, 110, 243, 440, 240, 449, 460, & 350 door styles. Additionally, magazine slots are also not available on 002C-449 & 003 door styles.

** Peepsite available in Bright Brass, Chrome (recommended for use with Satin Nickel hardware finish) and Aged/Antique (recommended for use with Black, Oil Rubbed Bronze or Antique Brass hardware finish) with 5-year finish warranty.



OPTIONS

The Hinge Straps, Clavos and Speakeasy are options that can give your entryway an old world look. Combine these options with our Signet® Knotty Alder Series to achieve a rustic or antique style. Hinge Straps, Clavos and Speakeasy are constructed of durable flat black aluminum.

HINGE STRAPS Available on all door styles shown on opposite page

 Available as an Impact Shield product.



CLAVOS Available only on door styles shown with planks on opposite page
(002CP-449, 002CP-437, 8' 002CP-449 and 8' 002CP-437)

 Available as an Impact Shield product.



SPEAKEASY Available on all door styles shown below except for 8' 002C-437 and 8' 002CP-437

NOT tested for Certified Wind Load or Impact Shield regions. (Doors with Speakeasy are not ENERGY STAR® certified.)
 ProVia® does not recommend entry doors with Speakeasy applications in the Northern climate zone. We also recognize some of the North-Central climate zone areas are not suitable for this application as well. We recommend this application to be used only in the South-Central and Southern climate zones. Speakeasy applications carry a 5-year limited warranty. See price book for more details.



Exterior



Interior

IRON DOOR

Not available on Embarq



Exterior



Interior

SEA SPRAY GLASS DOOR

(single pane)

Not available on Embarq

FAUX SPEAKEASY

Enjoy the decorative look of a speakeasy without impeding the energy efficiency of the entry door. Available on all door styles shown below.



SIGNET® & EMBARQ® FIBERGLASS DOOR STYLES

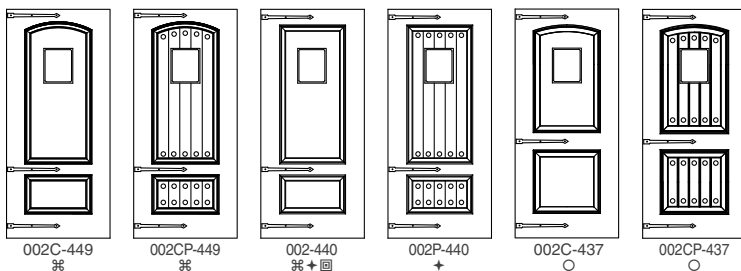

8' SIGNET FIBERGLASS DOORS

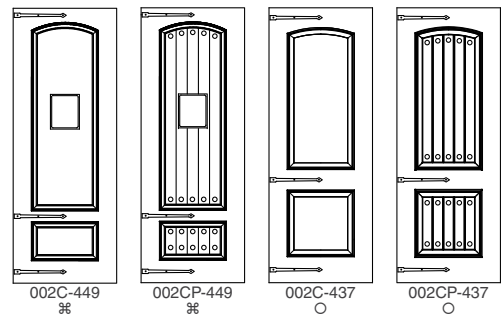

- ⌘ Signet/Embarq Cherry
- + Signet/Embarq Oak
- Signet/Embarq Knotty Alder
- Signet Smooth

Options

OPTIONS



PlexiDor® PET DOOR

(NOT available in Certified Wind Load or Impact Shield regions)
(Doors with Pet Door are not ENERGY STAR® certified)

Factory Installed - Available on Flush Doors Only

- Shatter resistant saloon-styled door panels provide durability and insulation
- Thermo-pane panels lined with high density weather seal for maximum energy efficiency
- Includes lock, two keys & steel security plate
- Available in White, Silver, and Bronze frames
- Available on the following styles: 001, 430DC-F, 430VNT-F, 430DC-EG-F, 430DC-IGT-F, 100DC, 101DC, 131DC & 306DC

Medium: 9" x 12" opening for pets up to 40 lbs.
Large: 11¾" x 16" opening for pets up to 100 lbs.
X-Large: 15¾" x 23⅝" opening for pets up to 220 lbs.



FREEDOM® PET DOOR

(NOT available in Certified Wind Load or Impact Shield regions)
(Doors with Pet Door are not ENERGY STAR® certified)

Factory Installed - Available on Flush Doors Only

- Solid aluminum construction with locking panel
- Soft single flap for tight weather seal
- Antique White mitered aluminum frame
- Available on the following styles: 001, 430DC-F, 430VNT-F, 430DC-EG-F, 430DC-IGT-F, 100DC, 101DC, 131DC & 306DC
- Also available on storm doors. See pg. 156.

Medium: 8¼" x 12¼" opening for pets up to 40 lbs.
Large: 10¼" x 16¼" opening for pets up to 100 lbs.
X-Large: 13¾" x 23¾" opening for pets up to 220 lbs.



CASING

Put the finishing touch on the inside of your entryway with our beautiful interior casing. Available in Cherry, Mahogany, Fir, Oak or Poplar wood.



2 1/2" Modern ▲



2 1/2" Colonial ▲



3 1/2" Colonial ▲



2 1/2" Flat*



3 1/2" Flat*

Available for any door configuration including transoms.

Signet® stains are available on Cherry, Mahogany, Oak or Fir casing, and Heritage™ and Legacy™ stains are available on Oak or Poplar casing. Paint and glazed finishes are available on Poplar casing.

Custom Casing

Don't see a casing style you need? We have a custom casing program that can meet your needs. Contact your dealer for additional information on our Custom Casing program.

* Only available in Fir and Poplar

▲ NOT available in Fir



3" Wide Brickmold
Choose from our standard 2" brickmold or our wider 3" brickmold.

ALUMINUM PRE-FIT CLADDING

Cladding is worth the small investment. You can add cladding to any FrameSaver® or PermaTech™ Composite Frame.

- Protective
- Maintenance-free
- Stays beautiful
- Factory applied

TEXTURED CLADDING COLORS

Snow Mist	Café Cream	Chateau
Sandpiper Beige	Sandstone	Sterling Gray
Clay	Geneva Blue	Forest Green
Enzian Blue	Vallis Red	Mountain Berry
Tudor Brown	Oak	Cherry
Rustic Bronze	Coal Black	Nightfall

TUFTEX SMOOTH CLADDING COLORS

Aluminum trim coil with mar-resistant smooth finish.

Snow Mist	Sandpiper Beige	Sandstone◊	Classic Bronze*
-----------	-----------------	------------	-----------------

◊ Smooth Sandstone cladding is a close match, but not an exact match to Sandstone paint color.

* Smooth Classic Bronze cladding does not match Rustic Bronze cladding color or Rustic Bronze paint color.

HINGED PATIO DOORS

Hinged Patio Doors are swinging patio door systems available in 2 or 3-lite units and constructed of the same solid quality Signet® and Heritage™ Fiberglass, and Legacy™ Woodgrain Textured or Smooth Steel doors as our entry door units.

Hinged Patio Doors with Heritage Fiberglass are NOT available in Certified Wind Load regions.



PATIO DOOR STANDARD FEATURES



A keyed **Schlage®** flair handleset with a **Maximum Security thumbturn deadbolt** is included. Choose from bright brass, antique brass, satin nickel or aged bronze finish. Optional Lifetime finishes available.



The lock area is reinforced with a **20-gauge steel security plate** for added strength.



Spring-loaded latch system automatically engages upon closing. Latch also includes interior locking feature. **BetterVue® fiberglass screen mesh** is standard. Heavy-duty fiberglass, aluminum or SeeVue® stainless steel screen is optional.



Suspended by ball bearing rollers this **top-hung heavy-duty aluminum screen frame** reduces binding, creating effortless operation. Screen frames are available in all 16 paint colors.



Z-AC™ Threshold with an auto-adjusting riser. Available in Mill or Anodized Bronze Finish

DOOR SWING

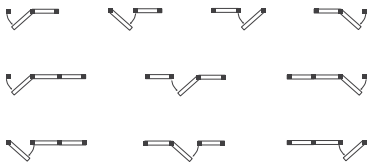

OPTIONS

Custom Widths and Heights - Need a little more height or a little less width? We are pleased to offer customized patio door widths and heights in 1/8" increments.

Door Swing - (Doors viewed from above. Inswing only.)

Finishes - Patio doors are available in all finishes shown on pages 95-100.

* Optional Aluminum Frame Cladding will increase brickmold to brickmold width by 1/4" and height by 1/8". Not all sizes available in all door types.



VINYL SLIDING PATIO DOORS

Vinyl Sliding Patio Doors are tested against the most stringent industry standards for air and water infiltration, wind load resistance, ease of operation, forced entry and much more. This means you'll have lower heating and air-conditioning costs, easier cleaning, low maintenance and increased comfort.

LIFETIME LIMITED WARRANTY
Includes Glass Breakage & Seal Failure

 **VINYL SLIDING PATIO DOOR**
IMPACT SHIELD FEATURES

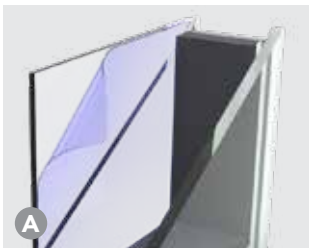

All glass for Impact Shield Products is laminated to provide protection against wind-borne debris.



Additional heavy aluminum interlock on center stile adds durability and strength.





All Vinyl Sliding Patio Doors
are ENERGY STAR® Certified



Suspended by ball bearing rollers this top-hung heavy duty aluminum screen frame with BetterVue® fiberglass mesh reduces binding, creating effortless operation.



FineLine™ technology gives patio door corners a cleaner look. Standard on all laminated Endure™ patio doors with the option to upgrade on white, beige and sandstone.



Strong, multi-chamber profiles and 4 7/8" frame depth offer greater thermal efficiency and increased sound abatement. (Endure Patio Door frames have Neopor® insulation).



AccuVent™ is ProVia's proprietary design featuring a sash lever combined with a top mounted ratchet and lock system allowing multiple venting locations. Standard for Endure, optional for Aspect.

AccuVent™ has a clean, sophisticated look with an ergonomic finger-tipped lever designed for ease of use.

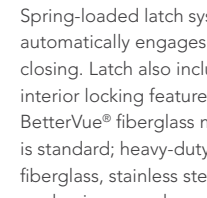

Spring-loaded latch system automatically engages upon closing. Latch also includes interior locking feature. BetterVue® fiberglass mesh is standard; heavy-duty fiberglass, stainless steel or aluminum mesh is optional.

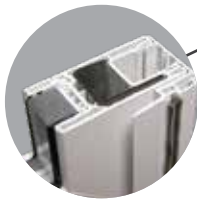

Galvanized steel reinforced panels.



Sill is reinforced with galvanized steel. Pair that with our patented water draining system, and the results are an efficient and durable base for our patio door.



Fixed and mobile panel rails meet and interlock perfectly, making removal from the outside virtually impossible. Lower sill design provides safer entry and exit.



The foot lock adds peace of mind when you want to leave the door open for ventilation yet keep would-be intruders out. Standard for Aspect, optional for Endure.



Patented sliding system features four adjustable 1" wheels per operating panel.

Vinyl Sliding Patio Doors

OPTIONS

INTERNAL GRIDS



Internal Grids
Triple Glazed Glass



Internal Grids
Double Glazed Glass



Contoured



Flat



V-Groove

SAMPLE GRID PATTERNS



Colonial 2V5H



Cottage 1V2H



Double Prairie



Cottage TS-2V1H



Single Prairie

INTERNAL BLINDS (NOT tested for Impact Shield regions)



Exterior



Interior

- Blinds tilt, raise and lower using the convenient fingertip adjustment slides
- Easy to clean; no more dusting of blinds
- Internal Blinds are available in silver, champagne, white, cream or tan.
- 10-Year Limited Warranty
- Available in standard and custom sizes (see price list for availability)
- Available in 2, 3 and 4 lite models



Blinds with Low-E on surface
2 and 4 are ENERGY STAR®
certified nationwide

CONFIGURATION Available in 2, 3 or 4-panel configurations in both standard and custom sizes

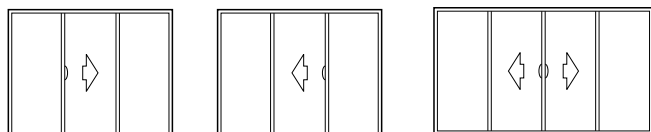
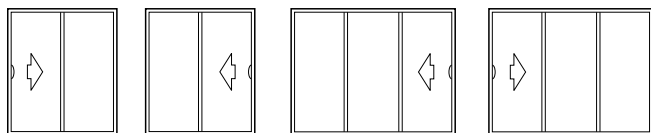

Only available in 2-panel configuration in Certified Wind Load regions. Sidelites and transoms must be installed in a separate opening or use approved engineering mulls.

Only available in 2-panel configuration in Impact Shield regions. Sidelites and transoms are NOT available.



Fixed sidelites



Transoms

PATIO DOOR & INTERNAL GRID COLORS

Exterior	White	White	White	White
Interior	White	Classic *Oak	Dark *Oak	Traditional *Cherry
Beige	White Woodgrain*	Classic *Oak	Dark *Oak	Traditional *Cherry
Sandstone	White Woodgrain*	Classic *Oak	Dark *Oak	Traditional *Cherry
Classic Bronze*	Classic Bronze*	Classic *Oak	Dark *Oak	Traditional *Cherry
White	Classic *Oak	Dark *Oak	Traditional *Cherry	

* Laminated Vinyl
Always refer to our color selector for accurate color representation.

HARDWARE Standard Mortise Hardware

Our Standard Mortise Hardware is available in White, Beige, Sandstone and Black.



Optional Mortise Hardware (with keylock)

Schlage® C Keyway on all keyed locking handles allow single key entry for the entire house (Also optional for Aspect)

Our Optional Mortise Hardware with keylock is available in White, Beige, Sandstone, Black, Aged Bronze, Antique Brass and Bright Brass.



OTHER OPTIONS

- Flat and Contoured Internal Grids
- Internal Blinds (White, Cream, Tan Silver, Champagne)
- Inspirations™ Art Glass
- ComforTech™ DLA-UV (standard), DLA-UV-HC, TLA-UV and TLK-UV. **NOT tested for Impact Shield regions.**
- Tinted Glass: Gray, Bronze, Green or Blue
- Privacy Glass (Obsure Pebble, Chinchilla, Taffeta, Waterfall, Gluechip)
- Single and Double Prairie Beveled Glass
- 8' wide units can be ordered assembled or knock-down. For Impact Shield regions, units less than 6' (width) x 6'8" (height) can be ordered assembled or knock-down. All larger units will be ordered knock-down.

PATIO DOOR & INTERNAL GRID COLORS

White	Beige	Sandstone
-------	-------	-----------

Always refer to our color selector for accurate color representation.

HARDWARE Standard Mortise Hardware

Our Standard Mortise Hardware is available in White, Beige, Sandstone and Black.



Optional Mortise Hardware (with keylock)

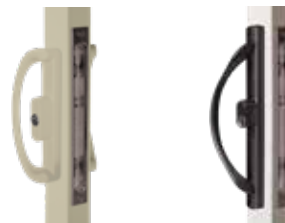

White, Beige, Sandstone, Black

Bright Brass
Satin Nickel
Flat Bronze*

*Flat Bronze coordinates (but is not an exact match) with Aged Bronze accessories.

OTHER OPTIONS

- Flat and Contoured Internal Grids
- Internal Blinds (White)
- ComforTech™ DLA (standard), DLA-HC, TLA and TLK. **NOT tested for Impact Shield regions.**
- Tinted glass: Gray, Bronze, Green or Blue
- Privacy glass (Obsure Pebble, Chinchilla, Taffeta, Waterfall, Gluechip)
- Single and Double Prairie beveled glass
- 8' wide units can be ordered assembled or knock-down. For Impact Shield regions, units less than 6' (width) x 6'8" (height) can be ordered assembled or knock-down. All larger units will be ordered knock-down.

Please refer to the Endure and Aspect Patio Door Brochures for more information.

STORM DOORS

Every storm door is individually customized to the highest standards in the residential market for homeowners who appreciate impeccable, uncompromising quality.



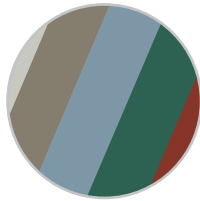

Durable, oven-baked polyester finishes are backed by a Lifetime Warranty for lasting beauty and low maintenance.

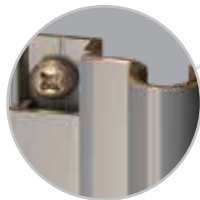

You'll appreciate the finished look of our **color matched aluminum installation screw covers**.



Smooth function is essential. That's why we include a **quality door closer** in every storm door package. Varies by model.

Our air release system features a continuous closing action without the delayed rebound action of previous generation closers.

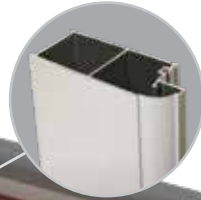

Extruded aluminum frame adds beauty to your door by virtue of the rounded cove molding along the glass edge of the extrusion.



Non-operable sashes are secured by our **color matched polycarbonate clips** or an **internal sash lock system**. Varies by model.

Each door features **quality hardware** that adds beauty and functionality to your new storm door. Varies by model.



Corrosion-proof corner gussets enhance the structural integrity of the door.



Our **bottom expander with sweep** allows for a beautiful custom-fit to any entry. Varies by model.

STORM DOOR DETAILS

The details are the small things that set our storm doors apart from the competition. A lot of small things add up to a big difference.

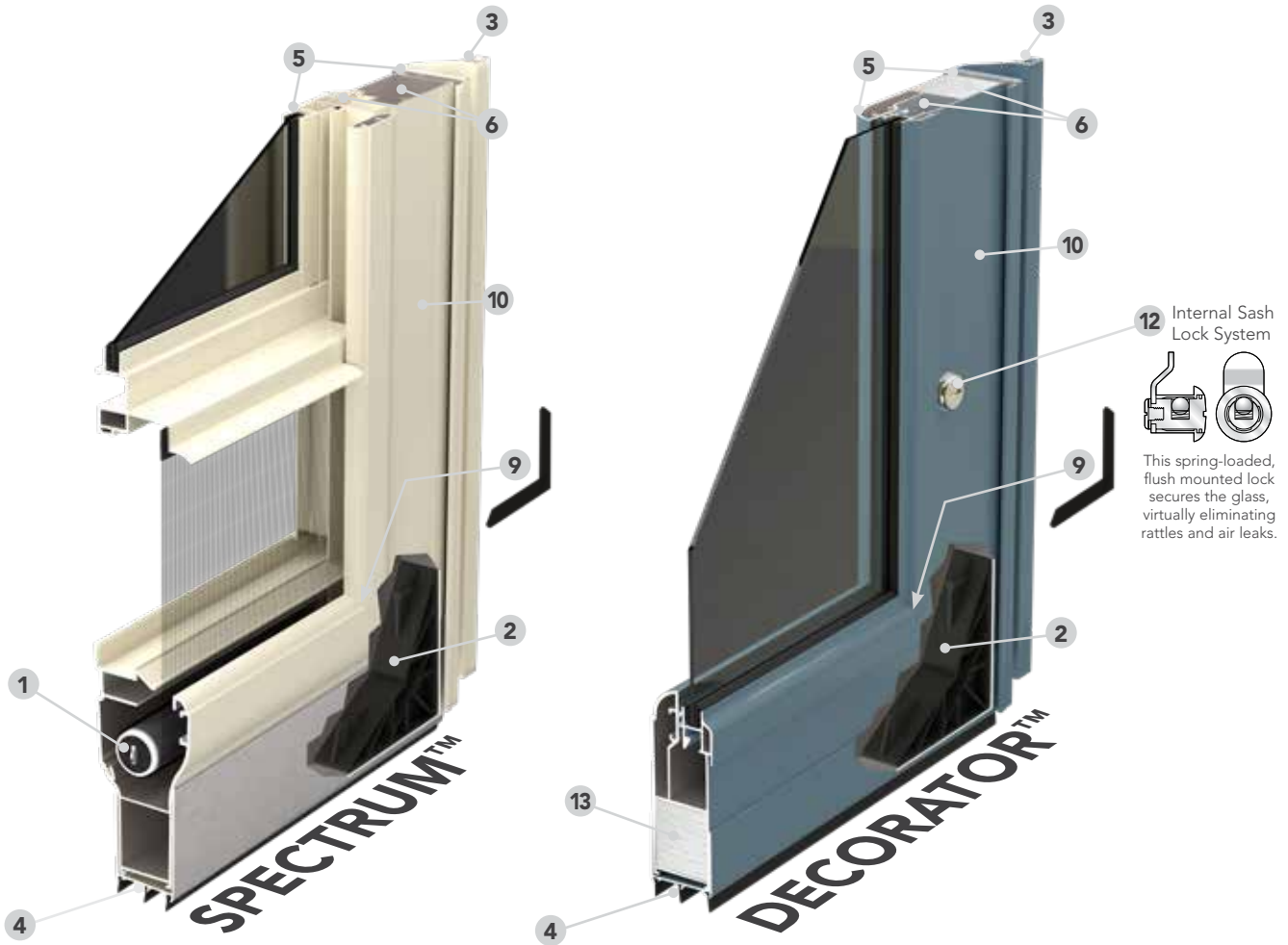

CONSTRUCTION

	Spectrum	Decorator	Deluxe	DuraGuard	Superview
1 InVent™ retractable screen system	●				
2 Outside corners are secured to corrosion-proof gussets, for structural integrity	●	●	●	●	●
3 Color matched aluminum installation screw covers enhance the appearance of your door	●	●	●	●	●
4 Triple bottom sweep eliminates drafts	●	●	●	●	●
5 The sculptured frame adds durability	1¼" x 4¾"	1¼" x 4"	1¼" x 3¾"	1¼" x 3¾"	1¼" x 2¾"
6 Multi-hollow construction provides greater strength and security than standard storm doors	●	●	●	●	
7 The reinforced aluminum kick panel adds durability	●		●	●	
8 The aluminum kick panel resists rust and adds strength	●		●	●	●
9 Corner keys provide added support to the inside of the door frame	●	●	●	●	●

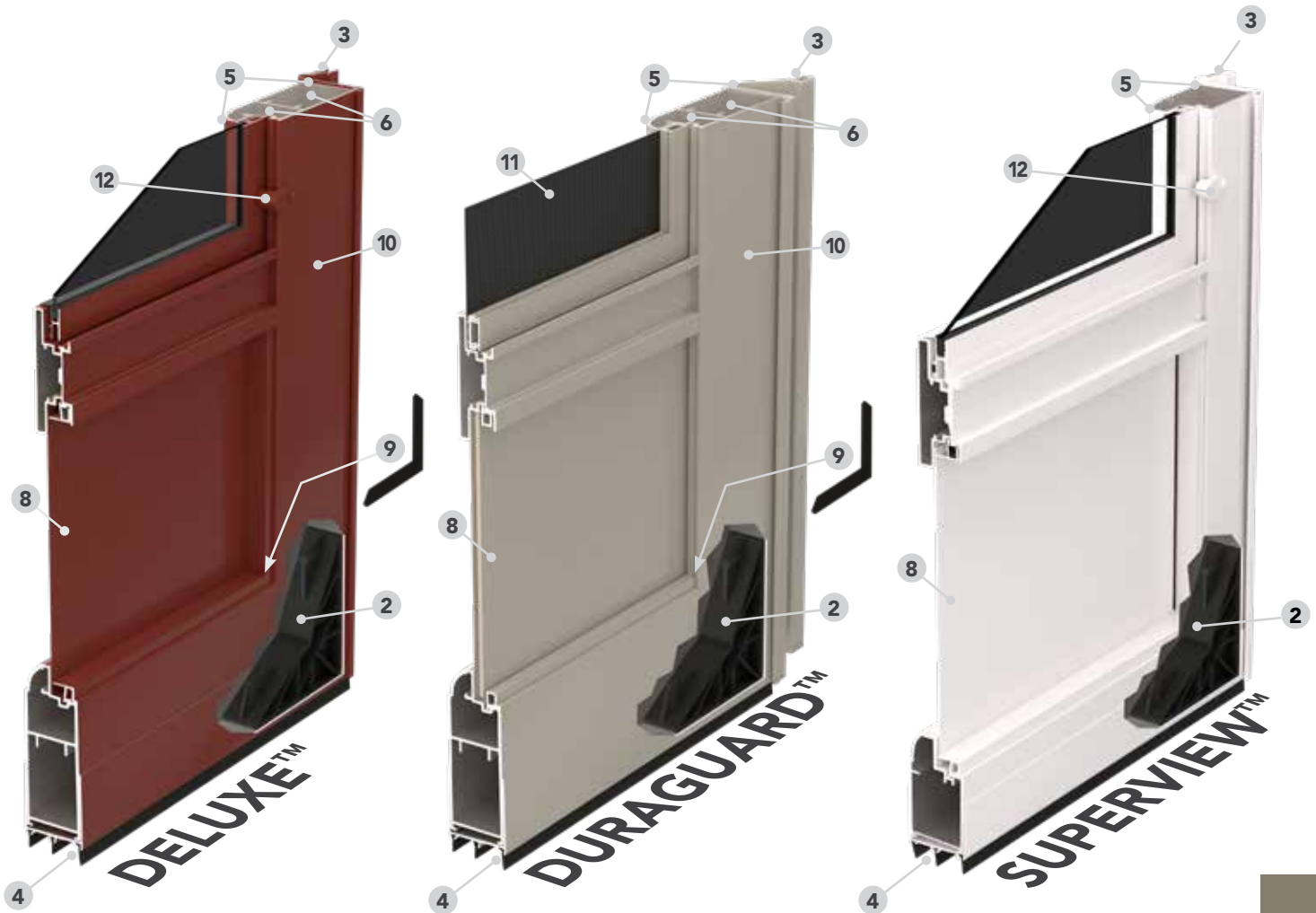

CONSTRUCTION

	Spectrum	Decorator	Deluxe	DuraGuard	Superview
10 Aluminum wall thickness up to 20% thicker than industry standard	●	●	●	●	
11 The .023 gauge stainless steel screen offers extra security and protection (12 x 12 mesh)				●	
12 Non-operable sash/screen secured by internal lock system or color matched polycarbonate clips		Internal Lock	Clips		Clips
13 Standard insulated frame core to help reduce air movement	Optional	●	Optional	Optional	
14 Screen included	●	Optional	●	●	●





STORM DOOR PAINT FINISHING SYSTEM

Our paint process is computer controlled, ensuring professional quality every time. Paint is electrostatically applied with a vertical hydraulic reciprocator using a turbo disc that atomizes the paint particles for better coverage of contoured extrusions.

STORM DOOR PAINT COLORS



† Limited Colors. Available on entry doors and storm doors. Matching cladding and caulking not available.

STORM DOOR TRENDING COLORS



Matching cladding, caulking, sash locks, clips, and closers NOT available for Trending Colors.

Always refer to our color selector for accurate color representation.

LIFETIME FINISH WARRANTY

For all Storm Doors



SPECTRUM™

STORM DOORS

Spectrum storm doors bring you smooth functionality, beauty and durability. Our exclusive top and bottom InVent™ retractable screen system allows you more venting options than ever.

SPECTRUM STORM DOORS INCLUDE:

- Two InVent retractable screens
- Triple seal bottom sweep
- 1¼" x 4¾" wide sculptured frame

LIFETIME LIMITED WARRANTY

Includes Glass Breakage

STANDARD HARDWARE & ACCESSORIES



Satin Nickel Sierra solid brass Mortise Hardware ◊

NOT recommended or warranted for coastal applications

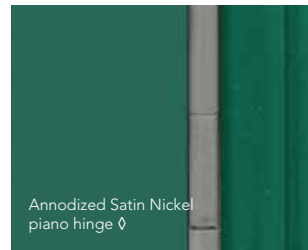

Anodized Satin Nickel piano hinge ◊

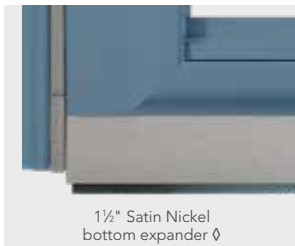

1½" Satin Nickel bottom expander ◊

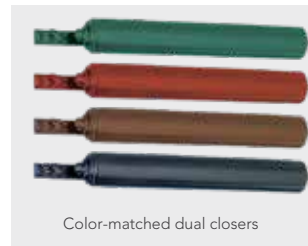

Color-matched dual closers



295-B Full View Double Prairie with Beveled Glass and Brass Inlay ◊
 295-Z Full View Double Prairie with Beveled Glass and Zinc Inlay
 295 Full View Double Prairie with Beveled Glass
 298-B Three-Quarter View with Beveled Glass and Brass Inlay ◊
 298-Z Three-Quarter View with Beveled Glass and Zinc Inlay
 298-VG Three-Quarter View with Beveled Glass



291 Full View (Inspirations Glass available)
 298 Three-Quarter View (Inspirations Glass available)
 279-C Colonial Half-Lite ‡
 279 Flush Half-Lite ‡
 292 Provincial Half-Lite ‡
 293 Crossbuck Half-Lite ‡
 291SH Full View (Only one InVent top screen and fixed bottom sash)



298SH Three-Quarter View (Only one InVent top screen and fixed bottom sash)
 274-CSH Colonial Half-Lite (Only one InVent top screen and fixed bottom sash) * ‡
 274SH Half-Lite (Only one InVent top screen and fixed bottom sash) * ‡

INSPIRATIONS™
ART GLASS
 Ask to see our Inspirations Art Glass brochure for our complete selection of designs, color palettes and style availability.

298-AME Americana (Timberland)

Acrylic is required (instead of tempered glass) for custom size storm doors where the sash size is greater than 20 square feet or the sash weigh is greater than 36 pounds. entryLINK will automatically change the glass selection to Acrylic based on these limits.

- * When top sash opens, it passes in front of kick panel.
- ◊ Bright Brass hardware, anodized brass piano hinge and brass-lock bottom expander are standard on Spectrum storm doors with brass caming.
- ‡ Available in 8' height

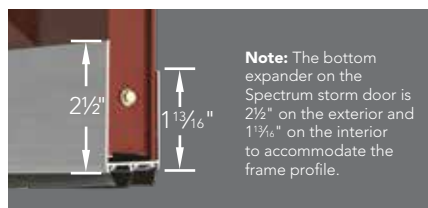



DECORATOR™

STORM DOORS

Decorator storm doors provide a stylish, fresh look to accent your entry door. Select one of the distinct styles from our Decorator storm doors.

DECORATOR STORM DOORS INCLUDE:

- Triple seal bottom sweep
- 1¼" x 4" wide sculptured frame

LIFETIME LIMITED WARRANTY
Includes Glass Breakage

STANDARD HARDWARE & ACCESSORIES

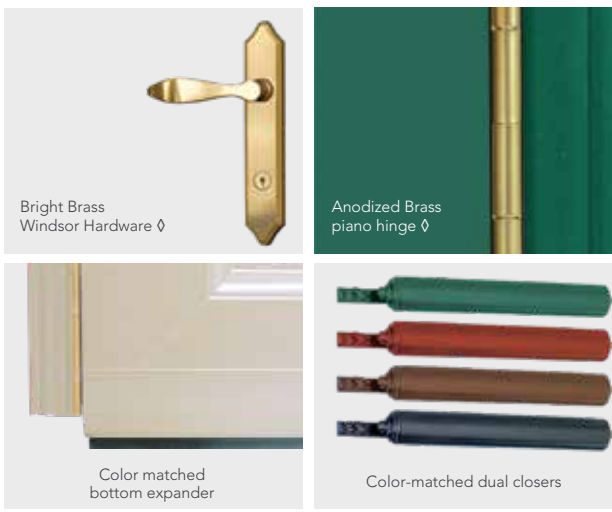

Bright Brass Windsor Hardware ◊

Anodized Brass piano hinge ◊

Color-matched bottom expander

Color-matched dual closers



591 Full View Archway with Beveled Glass



591-B Full View Archway with Beveled Glass & Brass Inlay



591-Z Full View Archway with Beveled Glass & Zinc Inlay ◊



595 Full View Double Prairie with Beveled Glass



#595-B Full View Double Prairie with Beveled Glass & Brass Inlay



#595-Z Full View Double Prairie with Beveled Glass & Zinc Inlay ◊



590 Full View ‡

**INSPIRATIONS™
ART GLASS**

Ask to see our Inspirations™ Art Glass brochure for our complete selection of designs, color palettes and style availability.



590-VIN Vintage (Timberland) ◊ ‡

Acrylic is required (instead of tempered glass) for custom size storm doors where the sash size is greater than 20 square feet or the sash weight is greater than 36 pounds. entryLINK will automatically change the glass selection to Acrylic based on these limits.



This spring-loaded, flush mounted lock secures the glass, virtually eliminating rattles and air leaks. Only available in Zinc finish.

Optional full screen with horizontal stabilizer bar available for all Decorator doors.

◊ Satin Nickel hardware and painted Satin Nickel piano hinge are standard on Decorator storm doors with zinc coming or Inspirations Art Glass.

‡ Available in 8' height



For French Storm Door information refer to the ProVia® Door Price List.



DELUXE™

STORM DOORS

Deluxe storm doors are the answer whether you're looking for additional light, ventilation or protection from the elements. You'll find the exact style you're looking for in our Deluxe storm doors.

DELUXE STORM DOORS INCLUDE:

- Triple seal bottom sweep
- 1¼" x 3¾" wide sculptured frame
- BetterVue® fiberglass screen

LIFETIME LIMITED WARRANTY

Includes Glass Breakage

STANDARD HARDWARE & ACCESSORIES



Black Contemporary Curve lever hardware

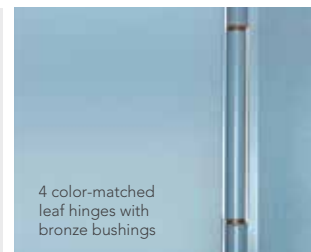

4 color-matched leaf hinges with bronze bushings



Color-matched bottom expander

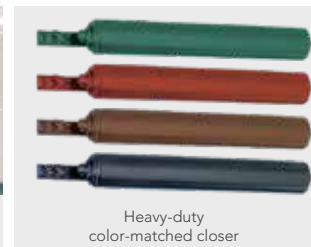

Heavy-duty color-matched closer



385 Full View Double Prairie with Beveled Glass (Includes screen*)



382 Full View with Beveled Glass (Includes screen*)



397 Full View (Includes screen*)



391 Full View Divided Lite (Includes top screen) ‡



396-V One-Lite with fixed .023 gauge stainless steel screen ventilated bottom & removable sash (Includes top screen*) ‡ (Inspirations Glass available)



396 One-Lite (Includes screen*) (Inspirations Glass available) ‡



399-M Modern Self-Storing (Includes full screen) ‡
Dent-Resistant Aluminum kick panel!



399 Self-Storing (Includes full screen*) ‡



398-M Modern Hi-Lite (Includes top screen) ‡
Dent-Resistant Aluminum kick panel!



398 Hi-Lite (Includes top screen) ‡



389-M Modern Self-Storing (Includes full screen*) ‡
Dent-Resistant Aluminum kick panel!



389 Self-Storing (Includes full screen*) ‡



379-C Colonial Self-Storing (Includes full screen) ‡
Dent-Resistant Aluminum kick panel!



379 Self-Storing (Includes full screen) ‡
Reinforced Aluminum kick panel!



392 Provincial Self-Storing (Includes full screen) ‡
Reinforced Aluminum kick panel!



394 Provincial (Includes screen) ‡
Reinforced Aluminum kick panel!



393 Crossback Self-Storing (Includes full screen) ‡
Reinforced Aluminum kick panel!



395 Crossback (Includes screen) ‡
Reinforced Aluminum kick panel!



374-C Colonial Half-Lite (Includes screen) ‡
Dent-Resistant Aluminum kick panel!



374 Flush Half-Lite (Includes screen) ‡
Reinforced Aluminum kick panel!



397-VIN Vintage (Timberland)

Acrylic is required (instead of tempered glass) for custom size storm doors where the sash size is greater than 20 square feet or the sash weigh is greater than 36 pounds. entryLINK will automatically change the glass selection to Acrylic based on these limits.

* Full and One-Lite screens have horizontal stabilizer bar.

‡ Available in 8' height



For French Storm Door information refer to the ProVia® Door Price List.

INSPIRATIONS™ ART GLASS

Ask to see our Inspirations Art Glass brochure for our complete selection of designs, color palettes and style availability.

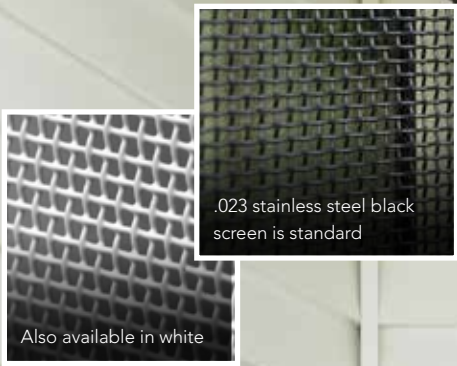

Note: White screen can appear to have different levels of transparency depending on the lighting and background.

DURAGUARD™

STORM DOORS

DuraGuard storm doors are exactly what you need if you're concerned about keeping your small children and pets safely inside. Select one of our doors with heavy-duty, non-removable stainless steel screening.

DURAGUARD STORM DOORS INCLUDE:

- Non-removable .023 stainless steel screen (only available on DuraGuard models)
- Triple seal bottom sweep
- 1¼" x 3⅝" wide sculptured frame

LIFETIME LIMITED WARRANTY

Includes Glass Breakage

STANDARD HARDWARE & ACCESSORIES

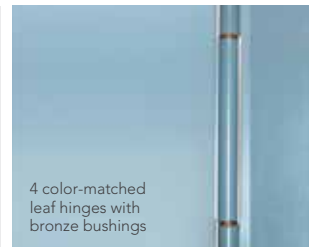
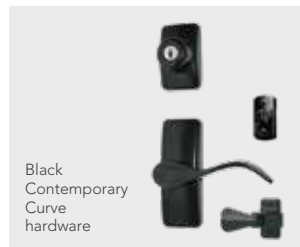



097 Screen Door ‡
097-G with removable
glass insert



096 Screen Door ‡
096-G with removable
glass insert ‡
Reinforced
Aluminum kick panel



096-GV With ventilated
bottom and removable
top and bottom sashes ‡



099 Self-Storing
Sash & Screen
Reinforced
Aluminum kick panel



099-M
Modern Self-Storing
Sash & Screen
Dent-Resistant
Aluminum kick panel



089 Self-Storing
Sash & Screen
Reinforced
Aluminum kick panel



089-M
Modern Self-Storing
Sash & Screen
Dent-Resistant
Aluminum kick panel



074 Flush Half Lite
(Removable sash) ‡
Reinforced
Aluminum kick panel



074-C
Colonial Half Lite
(Removable sash) ‡
Dent-Resistant
Aluminum kick panel



094 Provincial Half Lite
(Removable sash) ‡
Reinforced
Aluminum kick panel



095 Crossback Half Lite
(Removable sash) ‡
Reinforced
Aluminum kick panel



079 Self-Storing
‡
Reinforced
Aluminum kick panel



079-C Colonial
Self-Storing ‡
Dent-Resistant
Aluminum Kick panel



092 Provincial
Self-Storing ‡
Reinforced
Aluminum kick panel



093 Crossback
Self-Storing ‡
Reinforced
Aluminum kick panel

Acrylic is required (instead of tempered glass) for custom size storm doors where the sash size is greater than 20 square feet or the sash weigh is greater than 36 pounds. entryLINK will automatically change the glass selection to Acrylic based on these limits.

‡ Available in 8' height



For French Storm Door
information refer to
the ProVia® Door
Price List.



SUPERVIEW™

STORM DOORS

Superview storm doors offer a selection of doors constructed for style and value in one complete package.

SUPERVIEW STORM DOORS INCLUDE:

- Triple seal bottom sweep
- 1¼" x 2⅝" wide sculptured frame
- BetterVue® fiberglass screen

LIFETIME LIMITED WARRANTY

Includes Glass Breakage

STANDARD HARDWARE & ACCESSORIES



Black Pull handle
(Also available in white)



4 color-matched leaf hinges with bronze bushings



Color-matched bottom expander

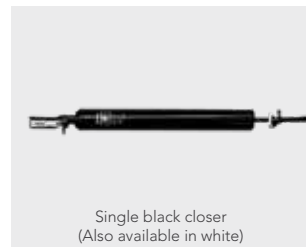

Single black closer
(Also available in white)



897 Full View
(Includes screen*)



896 One-Lite
(Includes screen*)



898 Hi-Lite
(Includes top screen)



899 Self-Storing
(Includes bottom screen)



895 Crossback
(Includes screen)

* Full and One-Lite screens have horizontal stabilizer bar

Superview storm doors are available in the following colors

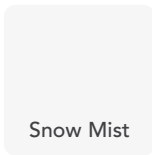

Snow Mist

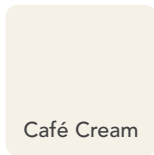

Café Cream



Rustic Bronze

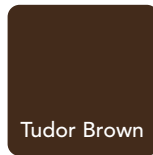

Tudor Brown

Always refer to our color selector for accurate color representation.



For French Storm Door information refer to the ProVia® Door Price List.

MORTISE HARDWARE

Mortise hardware adds a special touch to your storm door with a solid brass handleset to suit your style. Our Multi-Point Mortise hardware conveniently allows you to use the same key for your storm door and your ProVia® entry door.

Satin Nickel Sierra Mortise Hardware

MULTI-POINT

SIERRA (SOLID BRASS MORTISE)

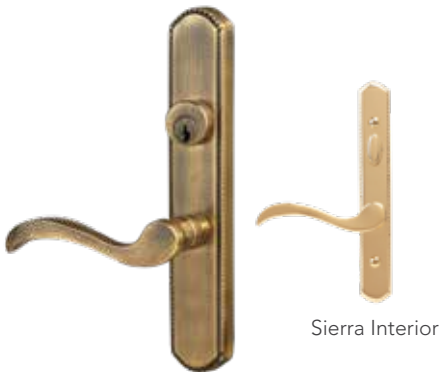

Sierra Interior

VENICE (SOLID BRASS MORTISE)



Venice Interior



Mortise hardware features a multi-point locking system for added strength and security not found on typical consumer-grade storm door hardware.

Requires a factory handleset prep and is not available on expander door.

AVAILABLE FINISHES

Lifetime Bright Brass

10-Year Antique Brass

Lifetime Satin Nickel

Lifetime Aged Bronze

Lifetime Black

HARDWARE FINISH AVAILABILITY

HARDWARE AVAILABILITY

Exterior Handle Styles	LIFETIME Bright Brass	LIFETIME Satin Nickel	LIFETIME Aged Bronze	LIFETIME Black	10-Year Finish Antique Brass	Spectrum™	Decorator™	Deluxe™	DuraGuard™	Superview™
Sierra	●	●	●	●	●	Standard*	■	■	■	
Venice	●	●	●	●	●	■	■	■	■	

● Interior handle finish matches exterior handle

■ Available as an option

SINGLE-POINT

WESTGATE



Westgate Interior

Optional Single-Point Mortise hardware, offering enhanced security, durability and style over standard surface-mounted hardware.

AVAILABLE FINISHES

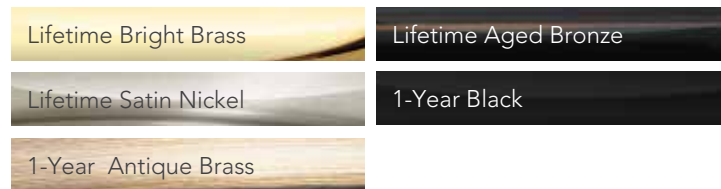

CAMBRIDGE



Cambridge Interior



Not available to be keyed to entry door.

Requires a factory handleset prep and is not available on expander door.

AVAILABLE FINISHES

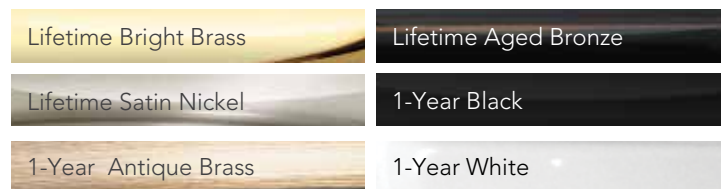

Hardware	FINISH AVAILABILITY						Hardware Availability				
	LIFETIME Bright Brass	LIFETIME Satin Nickel	LIFETIME Aged Bronze	1-Year Antique Brass	1-Year White	1-Year Black	Spectrum™	Decorator™	Deluxe™	DuraGuard™	Superview™
Cambridge	●	●	●	●	●	●	■	■	■	■	
Westgate	●	●	●	●		●	■	■	■	■	

● Interior handle finish matches exterior handle

■ Available as an option



HARDWARE

With both elegance and durability, our hardware makes the right first impression. Choose from our wide selection of solid hardware to customize your storm door.

Antique Brass Windsor Hardware

WINDSOR



Windsor Interior

TOWNSEND



Townsend Interior

AVAILABLE FINISHES

Lifetime Bright Brass

1-Year Antique Brass

1-Year Black

Lifetime Satin Nickel

Lifetime Aged Bronze

HARDWARE FINISH AVAILABILITY

HARDWARE AVAILABILITY

Exterior Handle Styles	LIFETIME Bright Brass	LIFETIME Satin Nickel	LIFETIME Aged Bronze	1-Year Antique Brass	1-Year White	1-Year Black	Spectrum™	Decorator™	Deluxe™	DuraGuard™	Superview™
Windsor	●	●	●	●	●	●	■	Standard	■	■	■*
Townsend	●	●	●	●	●	●	■	■	■	■	■*

● Interior handle finish matches exterior handle

■ Available as an option

† Standard color is black

* Not available on Superview Model 899

CONTEMPORARY CURVE LEVER



Contemporary Curve Interior

AVAILABLE FINISHES

Contemporary Curve

Lifetime Bright Brass

Lifetime Satin Nickel

1-Year Antique Brass

Lifetime Aged Bronze

1-Year Black

1-Year White

PUSH BUTTON



201

202/192

Push Button Interior
(201 & 202)

(Interior handle finish
matches exterior handle)

AVAILABLE FINISHES

Push Button/Pull Handle

1-Year Black

1-Year White

PULL HANDLE



181

182

Interior Handle

Push Button Interior (192)
and Pull Handle Interior

(Interior handle finish
matches exterior handle)

HARDWARE FINISH AVAILABILITY

Exterior Handle Styles	HARDWARE FINISH AVAILABILITY						HARDWARE AVAILABILITY				
	LIFETIME Bright Brass	LIFETIME Satin Nickel	LIFETIME Aged Bronze	1-Year Antique Brass	1-Year White	1-Year Black	Spectrum™	Decorator™	Deluxe™	DuraGuard™	Superview™
Contemporary Curve	●	●	●	●	●	●	■	■	Standard †	Standard †	■*
Push Button (DH201 & DH202)					●	●			■	■	■*
Push Button (DH192)						●					■
Pull Handle					●	●					Standard †

● Interior handle finish matches exterior handle

■ Available as an option

† Standard color is black

* Not available on Superview Model 899

ACCESSORIES



FREEDOM PET DOOR

Factory Installed - Available on Flush Doors Only

- Solid aluminum construction with locking panel
- Soft single flap for tight weather seal
- White mitered aluminum frame
- Also available on entry doors. See page 130.
- Also available on additional storm door styles.
- Only available with heavy-duty closer, Pet Door N/A with dual closers

Medium: 8¼" x 12¼" opening for pets up to 40 lbs.

Large: 10¼" x 16¼" opening for pets up to 100 lbs.

X-Large: 13¾" x 23¾" opening for pets up to 220 lbs.

PIANO HINGE & BOTTOM EXPANDER



Anodized Brass



Satin Nickel

Aged Bronze



#079 Self-Storing with mail slot option

MAGAZINE & MAIL SLOT

Lifetime Bright Brass, Lifetime Satin Nickel and Lifetime Aged Bronze magazine and mail slots are available on 074, 079, 279, 374 and 379.

Our **air release system** features a continuous closing action without the delayed rebound action of previous generation closers.



EASY-SET CLOSER

Just a slight push on the cap and it'll stay open. Push door open further and it releases. Color matched to door.

GLASS

TINTED GLASS

Tinted glass can help reduce UV transmittance, solar heat gain and glare. Each tinted glass option provides a room a whole new look, providing its own unique set of benefits. Be sure to choose the right one for your home.



Clear Glass

Bronze

High visible light transmittance
Warm glow to interior décors
Complements brick and stone
Ultraviolet light protection

Green

Subdues interior brightness
High visible light transmittance

Gray

Excellent glare control
Exceptional protection against interior fabric and color fading
Ultraviolet light protection

Blue

Low shading coefficient
High visible light transmittance
Solar performance (reduces solar heat gain)

PRIVACY GLASS

Choose from Obscure Pebble or Gluechip glass if you need light to filter in, yet want to maintain privacy.

OBSCURE PEBBLE



GLUECHIP







STYLE AVAILABILITY CHARTS

Refer to the charts below to find decorative glass availability for all entry door and sidelite styles.

DECORATIVE GLASS DOOR STYLES

	430				449		243			150				440				460				419				420			400		230		439		350		110	437	239	240
	Signet	Heritage	Legacy	Embarq	Signet	Embarq	Signet	Heritage	Embarq	Signet	Heritage	Legacy	Embarq	Signet	Heritage	Legacy	Embarq	Signet	Heritage	Legacy	Embarq	Signet	Heritage	Legacy	Embarq	Signet	Heritage	Legacy	Heritage	Legacy	Heritage	Legacy	Heritage	Legacy	Heritage	Legacy	Heritage	Legacy		
Mirage	MCOK	TS	TS		C	C			MCOS	TS	S	MCO	MCOS	TS	TS	MCO	A	TS	TS	A	MCO	TS	TS	MCO	FS				TS	S	TS	TS	TS	TS			S	TS		
Brookhaven	MCOK	TS	TS		C	C	CO	TS	CO	MCOS	TS	S	MCO	MCOS	TS	TS	MCO	A	TS	TS	A	MCO	TS	TS	MCO	FS		TS	TS	TS	S	TS	TS	TS	TS		TS	S	TS	
Manhattan	MCOK	TS	TS											MCOS	TS	TS	MCO	A	TS	TS	A					FS				TS	S								TS	
Essence	MCOK	TS	TS	MCO						MCOS	TS	S	MCO	MCOS	TS	TS	MCO	A	TS	TS	A									TS	S								TS	
Cheyenne	MCOK	TS	TS	MCO			CO	TS	CO	MCOS	TS	S	MCO	MCOS	TS	TS	MCO	A	TS	TS	A	MCO	TS	TS	MCO			TS	TS	TS	S			TS	TS	S		TS		
Symphony	MCOK	TS	TS	MCO	C	C	CO	TS	CO	MCOS	TS	S	MCO	MCOS	TS	TS	MCO	A	TS	TS	A	MCO	TS	TS	MCO	FS		TS	TS	TS	S			TS	TS			TS		
Berkley	MCOK	TS	TS	MCO										MCOS	TS	TS	MCO	A	TS	TS	A					FS				TS	S							TS		
Laurence	MCOK	TS	TS	MCO										MCOS	TS	TS	MCO	A	TS	TS	A					FS	TS	TS		TS	S							TS		
Carrington	MCOK	TS	TS	MCO	C	C	CO	TS	CO					MCOS	TS	TS	MCO	A	TS	TS	A	MCO	TS	TS	MCO	FS				TS	S							TS		
Tacoma														MCOS	TS	TS	MCO	A	TS	TS	A					FS												TS		
Somerset	MCOK	TS	TS	MCO	C	C	CO	TS	CO	MCOS	TS	S	MCO	MCOS	TS	TS	MCO	A	TS	TS	A	MCO	TS	TS	MCO	FS	TS	TS	TS	TS	TS	S			TS	TS	S	TS		
Carmen	MCOK	TS	TS	MCO										MCOS	TS	TS	MCO	A	TS	TS	A					FS				TS	S							TS		
Barcelona	MCOK	TS	TS	MCO										MCOS	TS	TS	MCO	A	TS	TS	A									TS	S							TS		
Constance	MCOK	TS	TS	MCO	C	C	CO	TS	CO	MCOS	TS	S	MCO	MCOS	TS	TS	MCO	A	TS	TS	A	MCO	TS	TS	MCO	FS		TS	TS	TS	S			TS	TS	S		TS		
Tranquility	MCOK	TS	TS	MCO			CO	TS	CO	MCOS	TS	S	MCO	MCOS	TS	TS	MCO	A	TS	TS	A	MCO	TS	TS	MCO			TS	TS	TS	S			TS	TS	S		TS		
Gemstone	MCOK	TS	TS	MCO			CO	TS	CO	MCOS	TS	S	MCO	MCOS	TS	TS	MCO	A	TS	TS	A	MCO	TS	TS	MCO				TS	S							TS			
Eclipse	MCOK	TS	TS	MCO			CO	TS	CO	MCOS	TS	S	MCO				A	TS	TS	A	MCO	TS	TS	MCO			TS	TS	TS	S	TS	TS	TS	TS						
Florence	MCOK	TS	TS	MCO			CO	TS	CO	MCOS	TS	S	MCO	MCOS	TS	TS	MCO	A	TS	TS	A	MCO	TS	TS	MCO			TS	TS	TS	S			TS	TS			TS		
Esmond	MCOK	TS	TS	MCO	C	C	CO	TS	CO	MCOS	TS	S	MCO	MCOS	TS	TS	MCO	A	TS	TS	A	MCO	TS	TS	MCO	FS		TS	TS	TS	S	TS	TS	TS	TS		S	TS		
Carlisle	MCOK	TS	TS	MCO	C	C	CO	TS	CO	MCOS	TS	S	MCO	MCOS	TS	TS	MCO	A	TS	TS	A	MCO	TS	TS	MCO	FS		TS	TS	TS	S			TS	TS			TS		
Twilight	MCOK	TS	TS	MCO																										TS	S					S				

SIGNET

- M** Mahogany
- C** Cherry
- O** Oak
- F** Fir
- K** Knotty Alder
- S** Smooth
- A** All

EMBARQ

- M** Mahogany
- C** Cherry
- O** Oak
- K** Knotty Alder
- S** Smooth

HERITAGE/LEGACY

- T** Textured
- S** Smooth

(See pages 10-21 for [Impact Shield](#) & [Windload](#) availability)

DECORATIVE GLASS SIDELITE STYLES

	130				140				160				460				120	139
	Signet	Heritage	Legacy	Embarq	Signet	Heritage	Legacy	Embarq	Signet	Heritage	Legacy	Embarq	Signet	Heritage	Legacy	Embarq	Signet	Legacy
Mirage	MCO	TS	TS	MCO	MCOS	TS	TS	MCO	MCOFS	TS	TS	MCO	MCOKS	TS	TS	MCOK	F	TS
Brookhaven	MCO	TS	TS	MCO	MCOS	TS	TS	MCO	MCOFS	TS	TS	MCO	MCOKS	TS	TS	MCOK	F	TS
Manhattan	MCO	TS	TS	MCO	MCOS	TS	TS	MCO	MCOFS	TS	TS	MCO	MCOKS	TS	TS	MCOK	F	
Essence	MCO	TS	TS	MCO	MCOS	TS	TS	MCO	MCOFS	TS	TS	MCO	MCOKS	TS	TS	MCOK		
Cheyenne	MCO	TS	TS	MCO	MCOS	TS	TS	MCO	MCOFS	TS	TS	MCO	MCOKS	TS	TS	MCOK		
Symphony	MCO	TS	TS	MCO	MCOS	TS	TS	MCO	MCOFS	TS	TS	MCO	MCOKS	TS	TS	MCOK	F	
Berkley	MCO	TS	TS	MCO	MCOS	TS	TS	MCO	MCOFS	TS	TS	MCO	MCOKS	TS	TS	MCOK	F	
Laurence	MCO	TS	TS	MCO	MCOS	TS	TS	MCO	MCOFS	TS	TS	MCO	MCOKS	TS	TS	MCOK	F	
Carrington	MCO	TS	TS	MCO	MCOS	TS	TS	MCO	MCOFS	TS	TS	MCO	MCOKS	TS	TS	MCOK	F	
Tacoma					MCOS	TS	TS	MCO	MCOFS	TS	TS	MCO	MCOKS	TS	TS	MCOK	F	
Somerset	MCO	TS	TS	MCO	MCOS	TS	TS	MCO	MCOFS	TS	TS	MCO	MCOKS	TS	TS	MCOK	F	
Carmen	MCO	TS	TS	MCO	MCOS	TS	TS	MCO	MCOFS	TS	TS	MCO	MCOKS	TS	TS	MCOK	F	
Barcelona	MCO	TS	TS	MCO	MCOS	TS	TS	MCO	MCOFS	TS	TS	MCO	MCOKS	TS	TS	MCOK		
Constance	MCO	TS	TS	MCO	MCOS	TS	TS	MCO	MCOFS	TS	TS	MCO	MCOKS	TS	TS	MCOK	F	
Tranquility	MCO	TS	TS	MCO	MCOS	TS	TS	MCO	MCOFS	TS	TS	MCO	MCOKS	TS	TS	MCOK		
Gemstone	MCO	TS	TS	MCO	MCOS	TS	TS	MCO	MCOFS	TS	TS	MCO	MCOKS	TS	TS	MCOK		
Eclipse	MCO	TS	TS	MCO					MCOFS	TS	TS	MCO	MCOKS	TS	TS	MCOK		
Florence	MCO	TS	TS	MCO	MCOS	TS	TS	MCO	MCOFS	TS	TS	MCO	MCOKS	TS	TS	MCOK		
Esmond	MCO	TS	TS	MCO	MCOS	TS	TS	MCO	MCOFS	TS	TS	MCO	MCOKS	TS	TS	MCOK	F	TS
Carlisle	MCO	TS	TS	MCO	MCOS	TS	TS	MCO	MCOFS	TS	TS	MCO	MCOKS	TS	TS	MCOK	F	
Twilight	MCL	TS	TS						MCOFS	TS	TS							

SIGNET

M Mahogany
C Cherry
O Oak
F Fir
K Knotty Alder
S Smooth
A All

EMBARQ

M Mahogany
C Cherry
O Oak
K Knotty Alder
S Smooth

HERITAGE/LEGACY

T Textured
S Smooth

(See pages 10-21 for **Impact Shield** & **Windload** availability)



PRIVACY GLASS & CLEAR GLASS

	Embarq/Signet				Signet		Heritage Fiberglass		Legacy 20-Gauge	
	Mahogany	Cherry	Oak	Knotty Alder	Fir	Smooth	Woodgrain	Smooth	Woodgrain	Smooth
Doors										
460	PC	PC	PC	PC	PC	PC	PC	PC	PC	PC
440	PC	PC	PC			PC	PC	PC	PC	PC
449		PC								
439							PC	PC	PC	PC
437										PC
430	PC	PC	PC	PC			PC	PC	PC	PC
430-F		C					C	C	C	C
350							C	C	C	C
243		PC	PC				PC	PC		
240									PC	PC
239										PC
230							PC	PC		PC
150	C	C	C			C	C	C		C
112								PC		PC
113						PC				
114						PC		PC		PC
115						PC		PC		PC
116						PC		PC		PC
420					PC	PC	PC	PC	PC	PC
419	PC	PC	PC				PC	PC	PC	PC
400							PC	PC	PC	PC
306							PC	PC	PC	PC
206							PC	PC	PC	PC
131		*					PC	PC	PC	PC
101							PC	PC	PC	PC
100							PC	PC	PC	PC
110										PC

	Embarq/Signet				Signet		Heritage Fiberglass		Legacy 20-Gauge	
	Mahogany	Cherry	Oak	Knotty Alder	Fir	Smooth	Woodgrain	Smooth	Woodgrain	Smooth
Sidelites										
770	PC	PC	PC	PC	PC	PC	PC	PC	PC	PC
160	PC	PC	PC	PC	PC	PC	PC	PC	o	o
140	PC	PC	PC			PC	PC	PC	o	o
139									o	o
130	PC	PC	PC				PC	PC	o	o
120						PC				
106									o	o
8' Doors										
460						PC	PC	PC	PC	PC
420						PC				
440		*								
430					*		PC	PC		PC
437					*					
150		*								
114						C		PC		PC
115						C		PC		PC
116						C		PC		PC
8' Sidelites										
160						PC	PC	PC	PC	PC
140		*		*						
130							PC	PC		PC
120						PC				
770		*		*			C	C		C

- P** Privacy
- C** Clear
- *** Embarq doors and sidelites are not available in 8' heights
- o** Steel Sidelites are made from 24-Gauge Steel

INTERNAL BLINDS

	Signet						Heritage Fiberglass		Legacy 20-Gauge	
	Mahogany	Cherry	Fir	Oak	Smooth	Knotty Alder	Woodgrain	Smooth	Woodgrain	Smooth
Doors										
460	WC	WC	WC	WC	WC	WC	WC	WC	WC	WC
440	WC	WC		WC	WC		WC	WC	WC	WC
430	WC	WC		WC		WC	WC	WC	WC	WC
230							W	W		W
Sidelites										
160							W	W	o	o
130							W	W	o	o
8' Doors										
430						WC	WC	WC		WC
440		WC								
8' Sidelites										
140		WC			WC					

- W** White Internal Blinds
- C** Colored Internal Blinds
- o** Steel Sidelites are made from 24-Gauge Steel

(See pages 10-21 for Impact Shield & Windload availability)

GRIDS

	Embarq/Signet				Signet		Heritage Fiberglass		Legacy 20-Gauge	
	Mahogany	Cherry	Oak	Knotty Alder	Fir	Smooth	Woodgrain	Smooth	Woodgrain	Smooth
Doors										
460	SI	SI	SI	SI	SI	SI	SIE	SIE	SIE	SIE
440	SI	SI	SI			SI	SI	SI	SI	SI
449		SI								
439							E	E	E	E
437									I	I
430	SI	SI	SI	SI			SIE	IE	SIE	SIE
420					SI	I	I	I	I	I
419	SI	SI	SI				I	I	I	I
410							E	E	E	E
400							IE	IE	IE	IE
230							SIE	SIE		SIE
240									SI	SI
Sidelites										
770	I	I	I	I	I	I	I	I	I	I
160	SI	SI	SI	SI	SI	SI	SIE	SIE	SI	SI
140	SI	SI	SI			SI	SI	SI	SI	SI
130	SI	SI	SI				SIE	SIE	SIE	SIE
120					SI					
8' Doors										
460					I	I	I	I		I
440		*								
420					SI					
430				*			SI	SI	S	SI
437				*						
8' Sidelites										
160					I	I	I	I		I
140		*		*						
130							I	I		I
120					SI					
770		*		*			I	I		I

- S** Simulated Divided Lites
- I** Internal Grids
- E** External Grids
- O** Steel Sidelites are made from 24-Gauge Steel
- *** Embarq doors and sidelites are not available in 8' heights



(See pages 10-21 for [Impact Shield](#) & [Windload](#) availability)

DISCOVER MORE

WEBSITE

ProVia.com makes it easy to explore and compare numerous door, window, siding, stone or roofing options in a straightforward, interactive way. Configure a door or window, visualize products on your home, explore color palettes, and learn about different architectural styles—all from our innovative Design Center. Save your favorite products, colors, photos or ideas throughout the site into your own ProVia portfolio for reference any time and share them across your favorite social media platforms. ▶

VISUALIZER

Let your imagination run free with this exterior home design tool. Select from a library of existing home styles or upload a photo of your own home.

In a few easy steps, update your siding color, add stone or metal roofing, configure windows, or create a one-of-a-kind entry door system.

Looking for professionally inspired color and product palettes? Apply one of our pre-selected Designer Collections to create a curb-appealing look. ▾



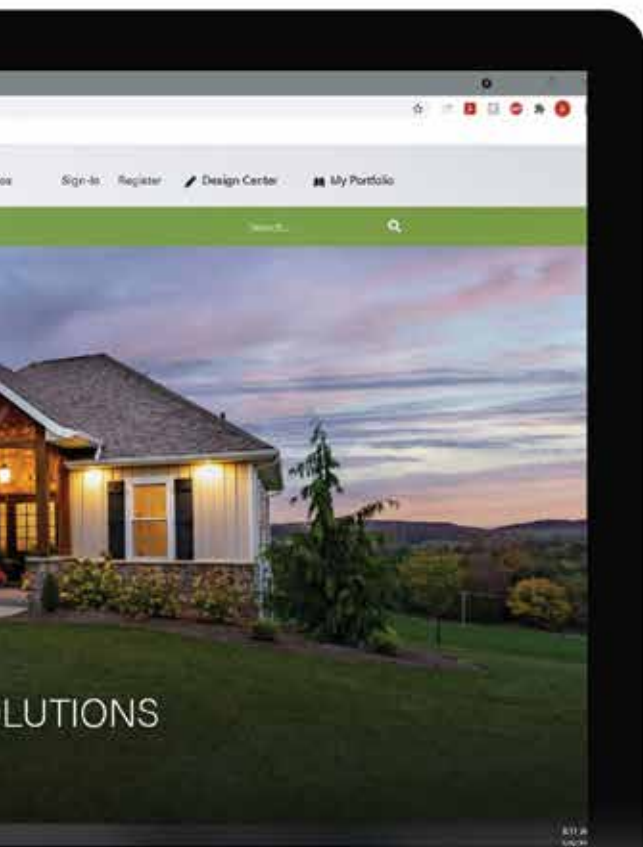

APP

Use the ProVia app to configure doors and windows or select from an extensive collection of vinyl siding, manufactured stone and metal roofing styles.

FEATURES

- Door and Window Configuration
- Vinyl Siding Profiles, Colors and Accessory Accents
- Manufactured Stone Styles, Color Palettes and Grout Options
- Metal Roofing Profiles, Trims and Colors
- Videos, Photo Galleries and Catalogs
- ProVia Dealer Locator



SOCIAL MEDIA

We love seeing how you apply our products to your home. Please share your photos with us. ▾

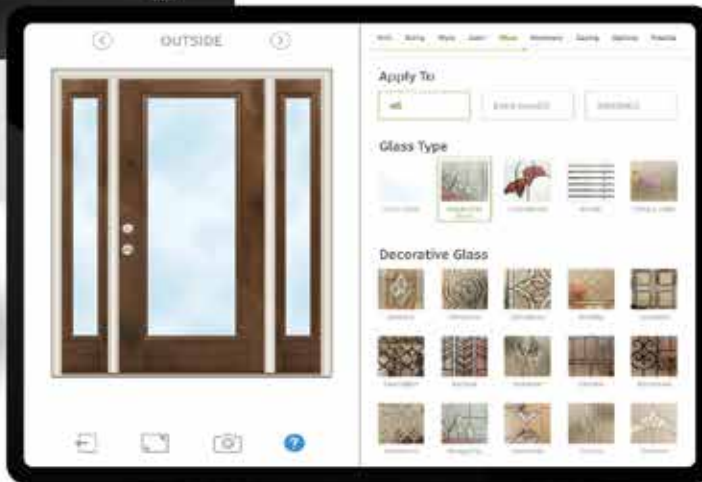

OUR MISSION:

— TO SERVE, BY CARING FOR —

DETAILS

IN WAYS OTHERS WON'T

At ProVia, we care about our customers as much as we do the products and services we meticulously provide. We combine old-world craftsmanship with state-of-the-art technology to deliver personalized care with every order. We invite you to experience ProVia's full line of products crafted The Professional Way - which includes the industry's best in doors, windows, siding, stone and roofing.

Browse our full line of products at
provia.com





Your Vision is
Our Inspiration



WINDOWS



SIDING



STONE



ROOFING



DOORS

provia.com



“To serve, by caring for details in ways others won’t.” It’s not just our mission, but a way of letting our light shine every day at ProVia®. We continually strive to put these words into action by providing unmatched quality and service. The P-icon symbolizes each employee’s commitment to devoting the utmost care, pride and quality into each building product we manufacture...it’s The Professional Way.



At ProVia, we manufacture energy efficient products and exercise corporate environmental stewardship by recycling, reducing pollution emissions and much more. In fact, our company has received repeated awards from the Environmental Protection Agency such as Partner of the Year - Sustained Excellence for Door and Window Manufacturing.



DOORS | WINDOWS
SIDING | STONE | ROOFING
provia.com

© 2022 ProVia
P-MK-03005-22 | 11/21

Distributed by:

